



WELMICA
LAMINATES

WELMICA LAMINATES PVT. LTD.

Opp. 66 KV Sub. Station, Before Millennium Tiles,
Rafaleshwar Road, Bhadiyad, Morbi- 363642, (Gujarat), INDIA

CUSTOMER CARE: **+91 95123 60016 / 95123 60022**

www.welmicalaminates.com | info@welmicalaminates.com



WELMICA
LAMINATES



KOREAN sheet
ANTI-SCRATCH CORE ACRYLIC



WELMICA
LAMINATES

KOR EAN

Elevate Interiors With Acrylic Brilliance

*Shahid
Kapoor*

KOREAN sheet
ANTI-SCRATCH CORE ACRYLIC

KOREAN



Korean Brilliance
Where Clarity Meets Luxury.

ABOUT WELMICA

Greetings from Welmica Laminates Pvt. Ltd., leading suppliers of luxurious decorative laminate sheets! At Welmica, we understand the need of coming up with aesthetic designs and unprecedentedly superior quality of designer laminates for your projects, and our state-of-the-art technology makes it possible for us to cater to it. We aim at revolutionising the sphere of laminate industry, and adding value to interior designing and décor by making wide collections and catalogues with sumptuous designs available to you. With designs created and curated by the best of our creators, we cater to the international market with an aim to establish global presence and eminence in our field as top laminate manufacturers in India and exclusive designer laminate manufacturing company in Morbi.

Our ever-evolving network authenticates the notability and renown throughout the industry, and we are proud of the manufacturing expertise that we have achieved through the years. Welmica takes pride in pursuing innovation and discovery while already being a well-established and adept organisation located at Morbi, Gujarat. At Welmica, we promise you sophisticated class in terms of style and appearance, and our ISI and ISO certificates ensure standard grade of quality. As Laminate Manufacturers our laminates make a perfect fit for every house décor, hotels, restaurants, motels, resorts, malls, offices and practically any corporate or residential place.

www.welmicalaminates.com



**ANTI
SCRATCH**
KOREAN SHEET

**RESIST THE SCRATCH.
REFLECT THE STYLE.**

Engineered with 1mm thickness for precision and flexibility, our premium Korean sheets are designed to withstand everyday wear and tear.

Featuring anti-scratch resistance and anti-fingerprint technology, they maintain a flawless, crystal-clear finish with low maintenance needs.

Built with modern technology, these sheets are borer and termite proof, ensuring long-lasting protection and hygiene. Crafted for versatility, they bend easily without cracking, making them perfect for innovative and seamless interior applications.



1MM
THICKNESS



ANTI-SCRATCH
RESISTANCE



ANTI
FINGER PRINT



LOW
MAINTENANCE



MODERN
TECHNOLOGY



BORER & TERMITE
PROOF



NO
CRACK



EASY
BENDABLE

Designed to Last,
Made to Impress.

KOREAN Sheet
ANTI-SCRATCH CORE ACRYLIC



**INSPIRE EVERY INCH.
TRANSFORM EVERY SPACE.**

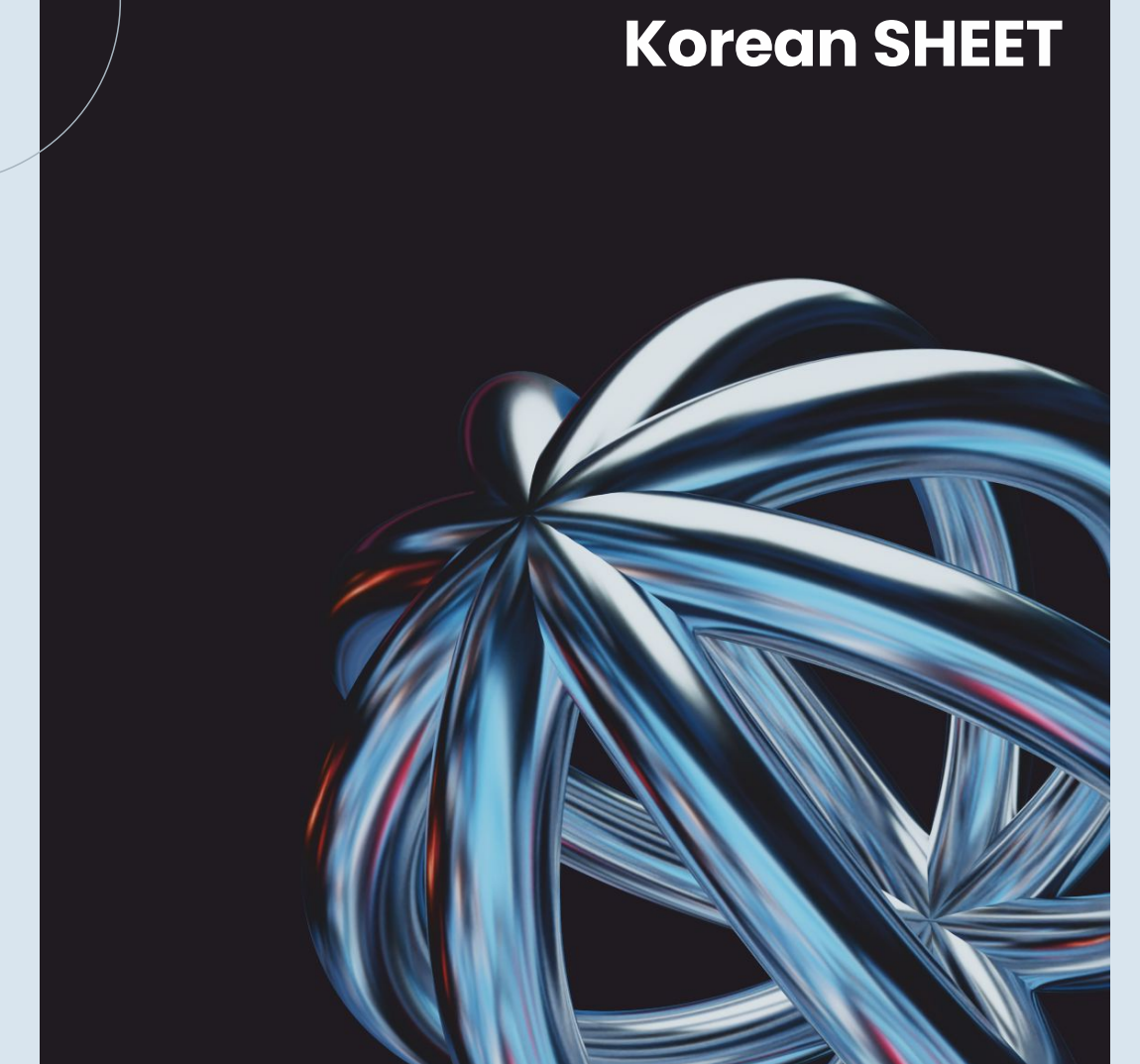

**PREMIUM
Korean SHEET**

Engineered with advanced technology, they seamlessly adapt to creative designs while maintaining a pristine, luxurious finish. Whether used for high-end wall paneling, furniture, or decorative applications, our Korean sheets provide long-lasting performance and timeless elegance, making them the perfect choice for sophisticated spaces.

www.welmicalaminates.com



DESIGNED TO LAST, MADE TO IMPRESS.

Crafted with modern innovation, our Korean sheets offer the perfect balance of strength and elegance. Designed in a premium 8x4 ft. (2440x1220 mm) size with a precise 1mm thickness, they bring versatility and sophistication to any project. Lightweight yet durable, these sheets maintain a pristine, luxurious look while providing the flexibility needed for seamless, high-end interior applications.

SHEET SIZE :
8X4 Ft.
(2440X1220MM)

THICKNESS :
1MM

Seamless Strength,
Timeless Shine

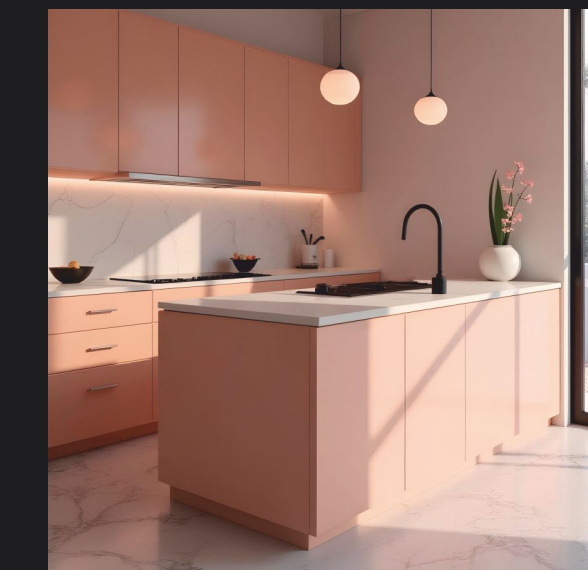

Korean Sheets
Deliver Precision

Crafted with modern innovation, our Korean sheets deliver precision, elegance, and lasting performance for seamless, luxurious interior transformations.



**The Art of Transparency,
The Power of Korean.**

Introducing Welmica Korean Sheets, a perfect fusion of premium quality and advanced technology designed for modern interior excellence.

Advantage	Welmica Korean Sheet	Acrylic with PVC
Health Index	ECO Friendly and No formaldehyde	Releases odour and formaldehyde
Flexibility	Bendable Till 90 Degrees	Slightly Bendable
Weather Fastness	Anti-yellowing	Easy yellowing

Features



**Premium
EB and UV surface**

- ★ Scratch Resistant
- ★ Anti-Fingerprint
- ★ Oil rub Resistant



**ECO Friendly
Raw Material**

- ★ Anti-yellowing
- ★ Water Proof
- ★ Easy to Bend

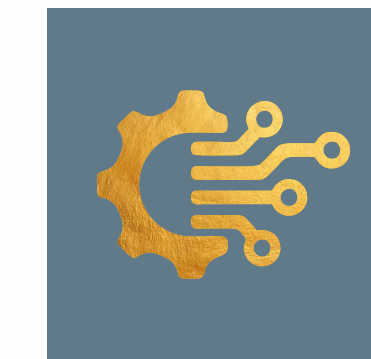

**Exclusive
Technology**

- ★ Seamless Edges
- ★ No Delamination
- ★ All size Customization

Crafted from eco-friendly raw materials with no formaldehyde emissions, these sheets ensure a healthy indoor environment with no odour release. Built with exclusive EB and UV surface technology, they deliver superior scratch resistance, anti-fingerprint protection, oil rub resistance, and long-lasting anti-yellowing properties. Engineered with Korean and PVC composition, the sheets offer exceptional flexibility, allowing 90° bending without cracks, seamless edges, and no delamination even under weather extremes.

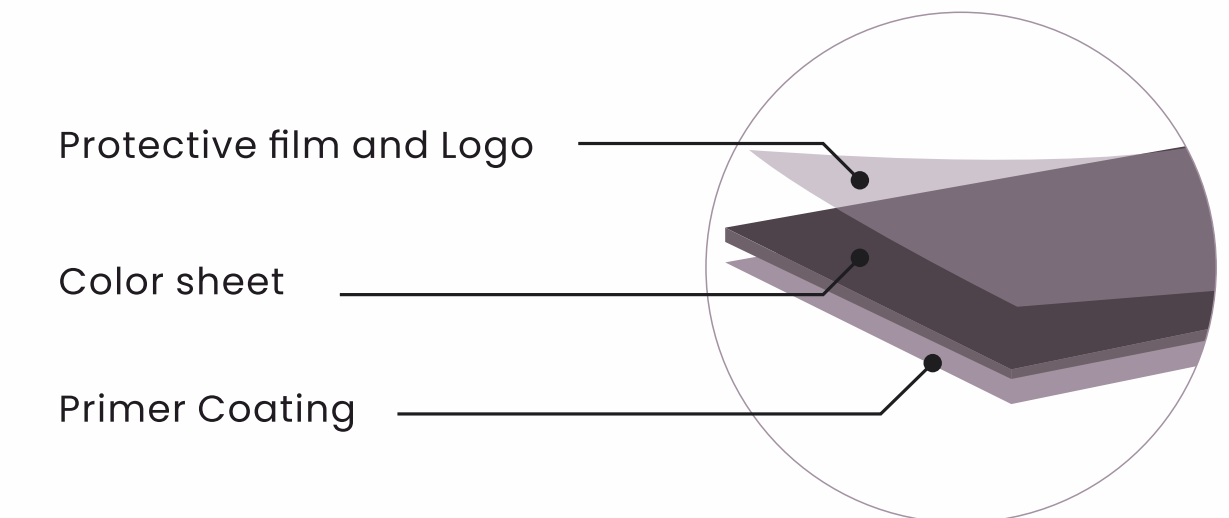

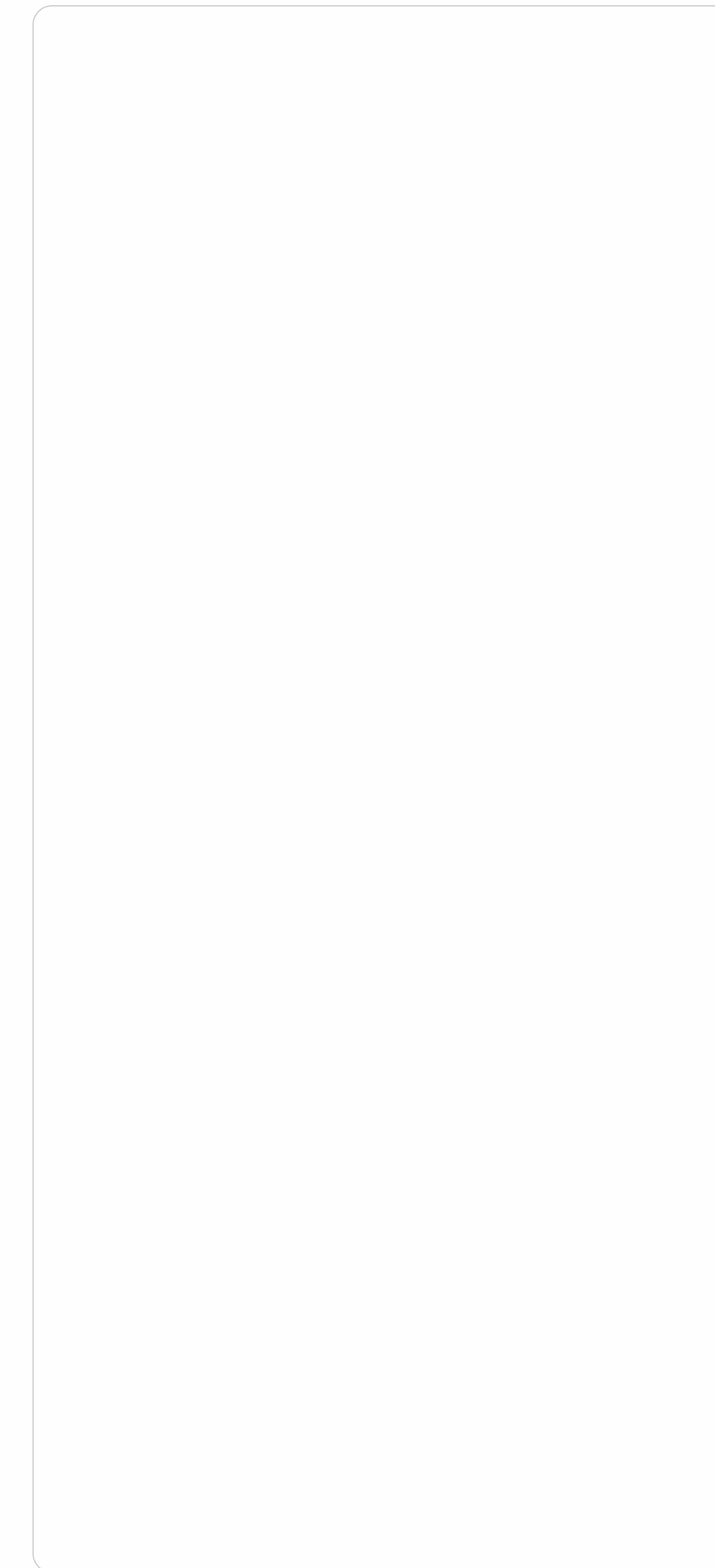

KO-ACR-601

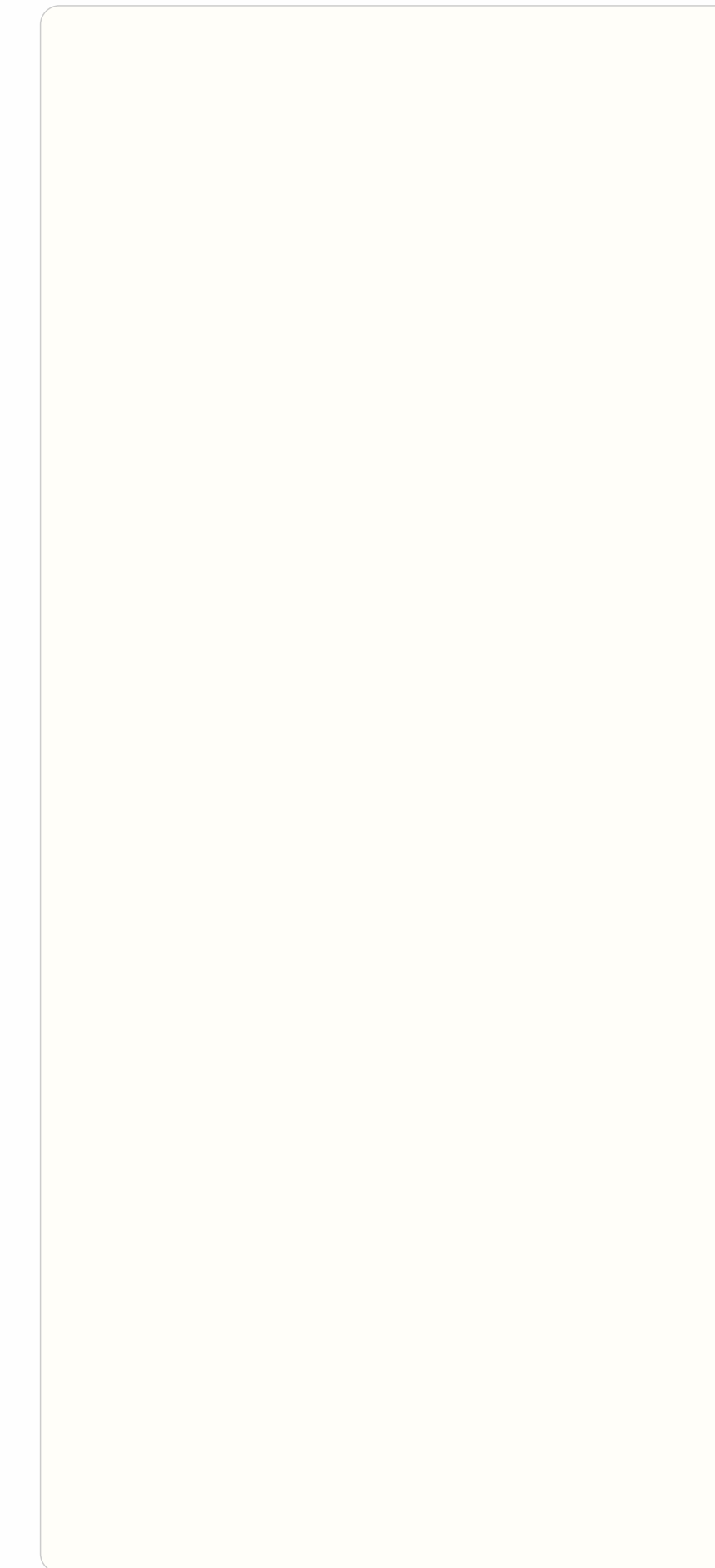

KO-ACR-602

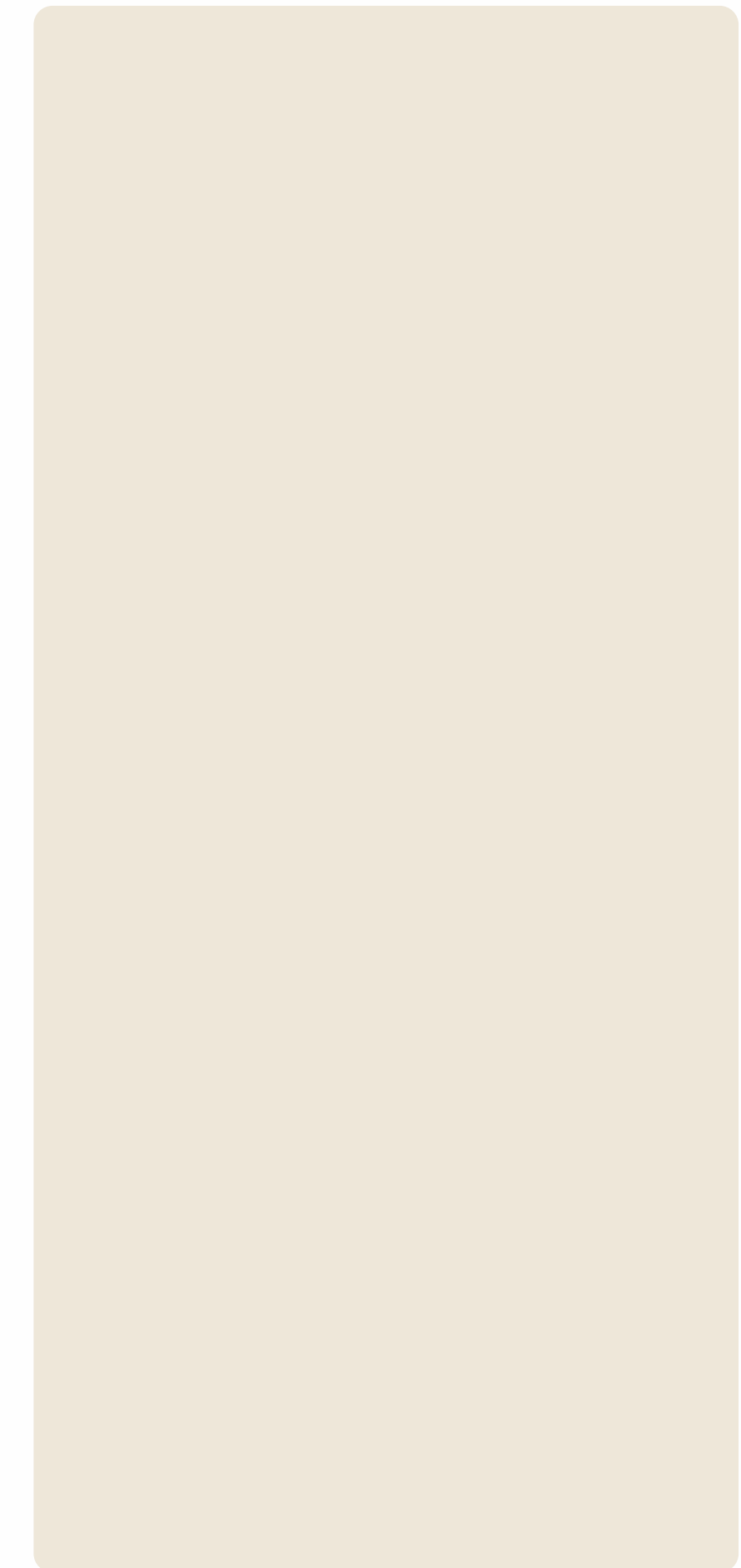

KO-ACR-604



**SPARKLE
FINISH**

 **WELMICA**
LAMINATES

KOREAN Sheet
CORE ACRYLIC LAMINATE

Designed to Shine,
Engineered to Perform.

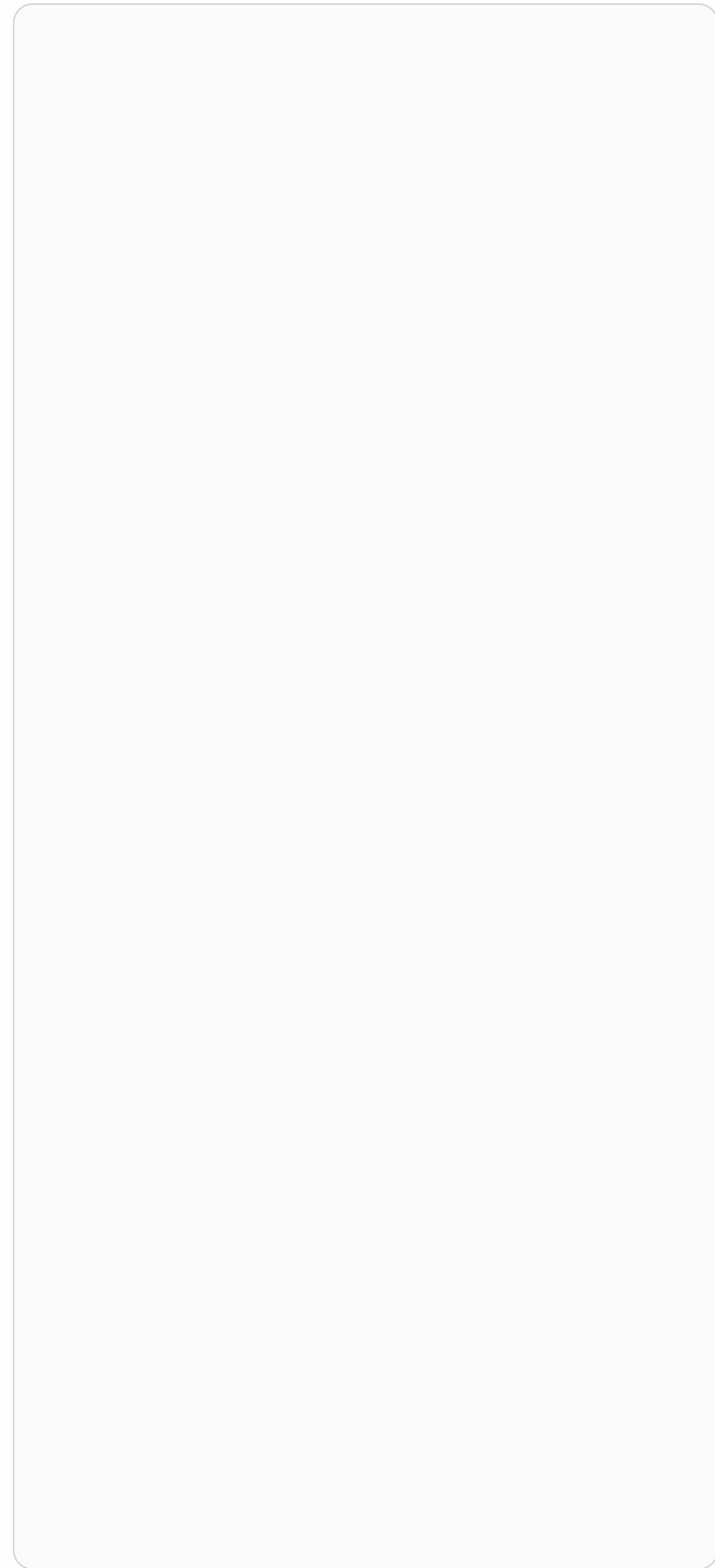

KO-ACR-603

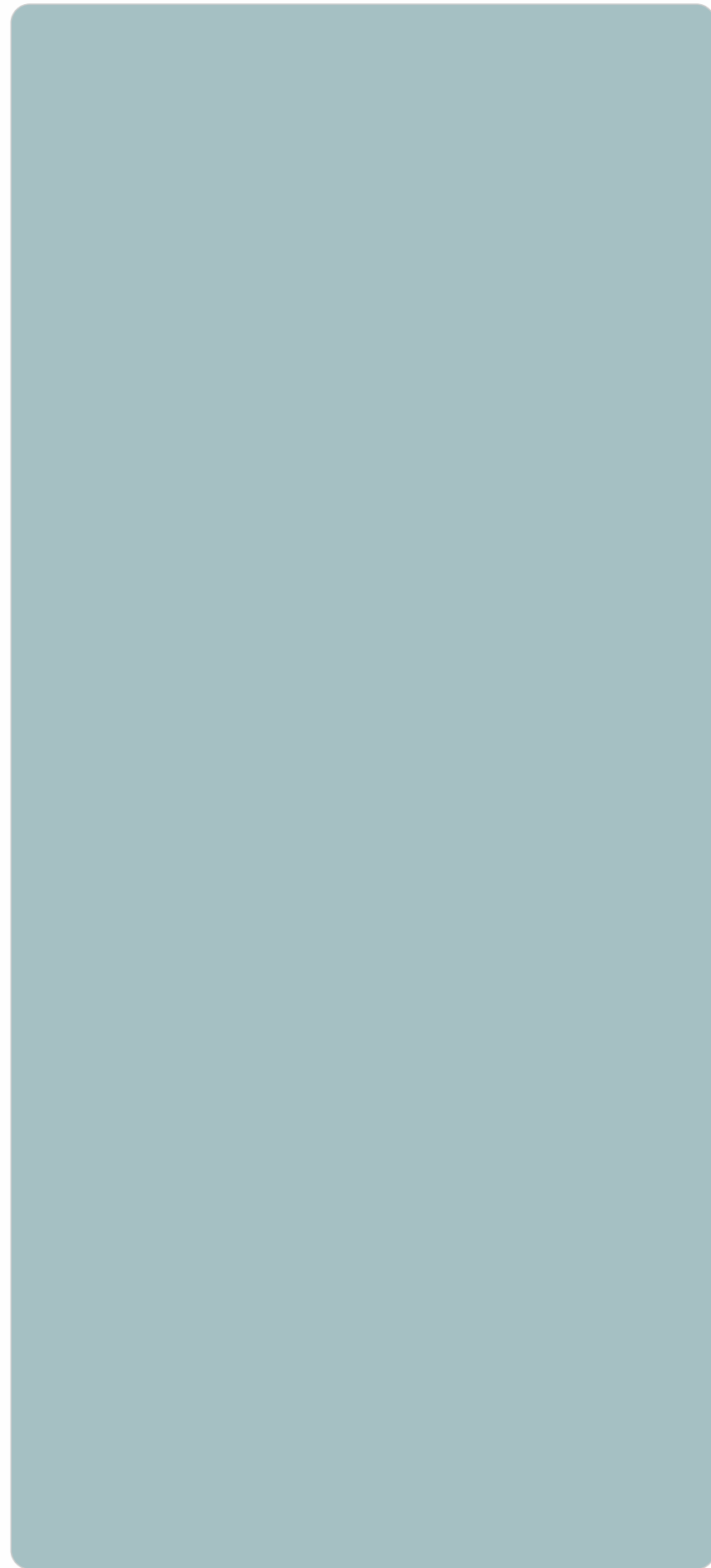

KO-ACR-605

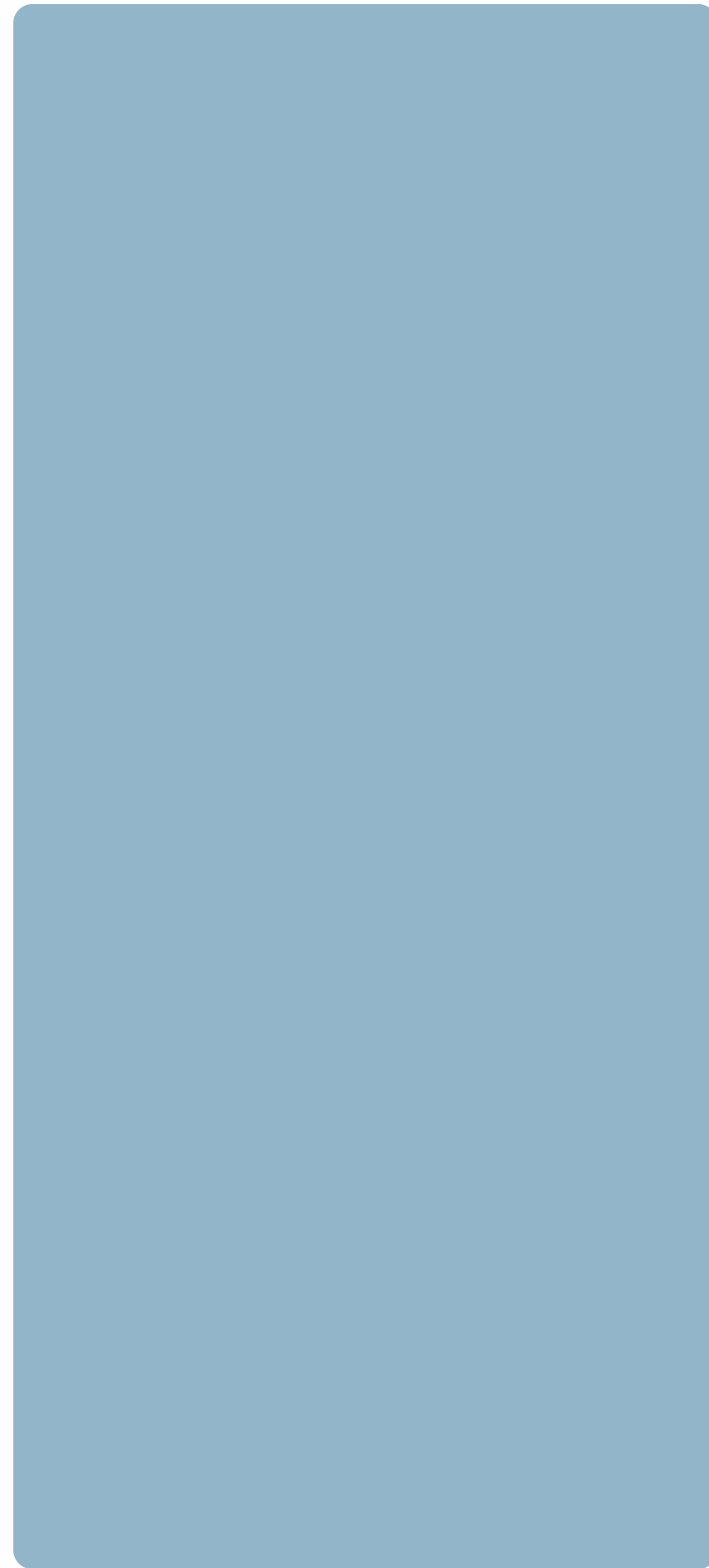

KO-ACR-606



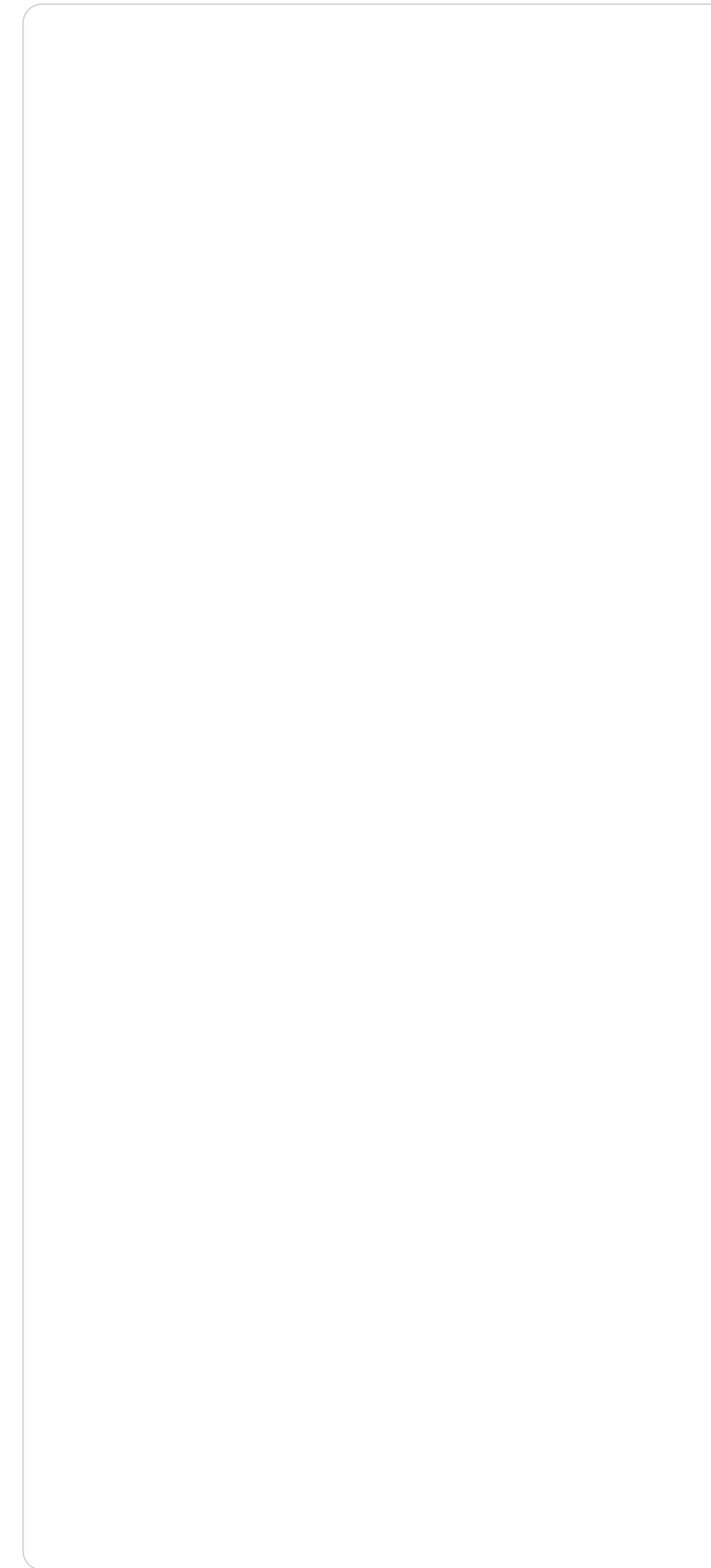

KO-ME-651

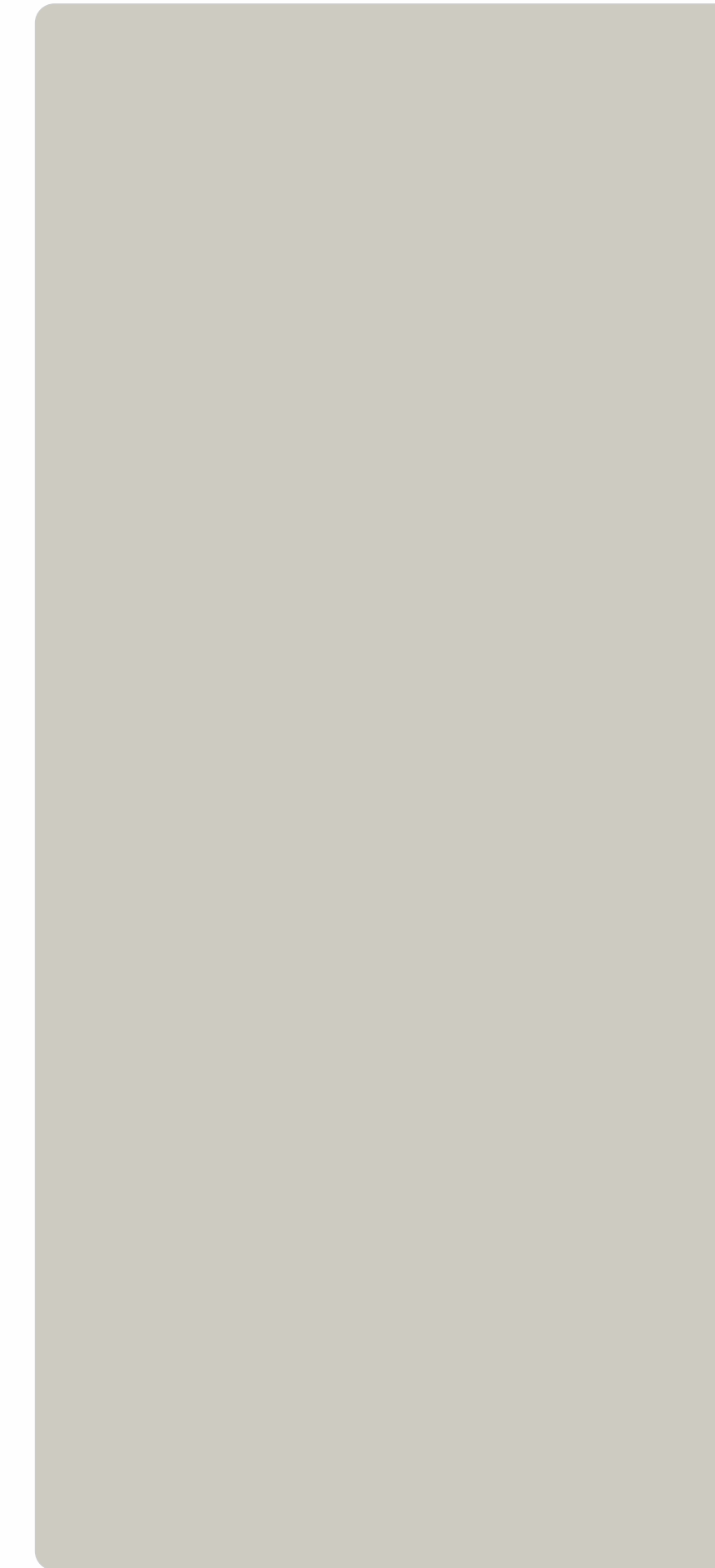

KO-ME-652

Shaping
Your Dream



Discover the seamless
integration of style

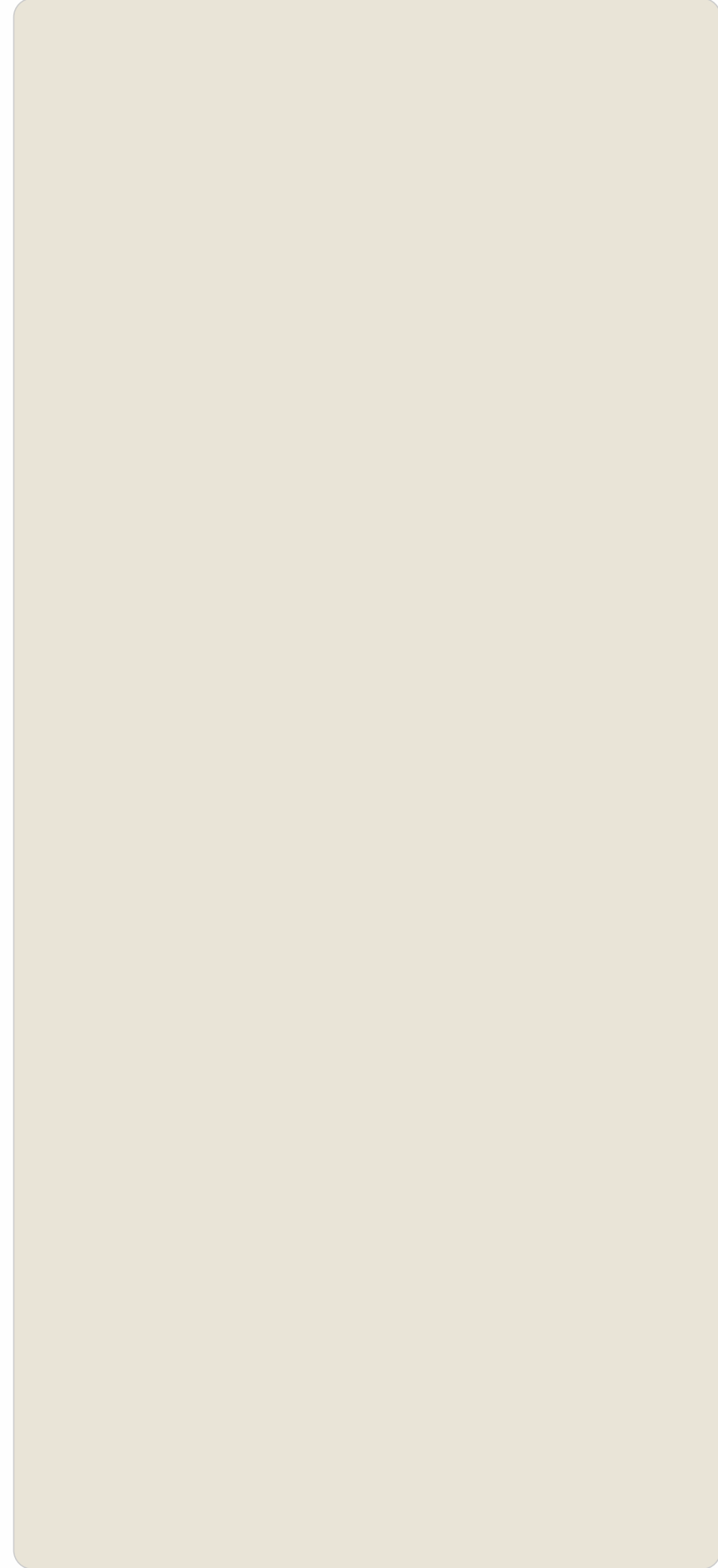

KO-ME-653

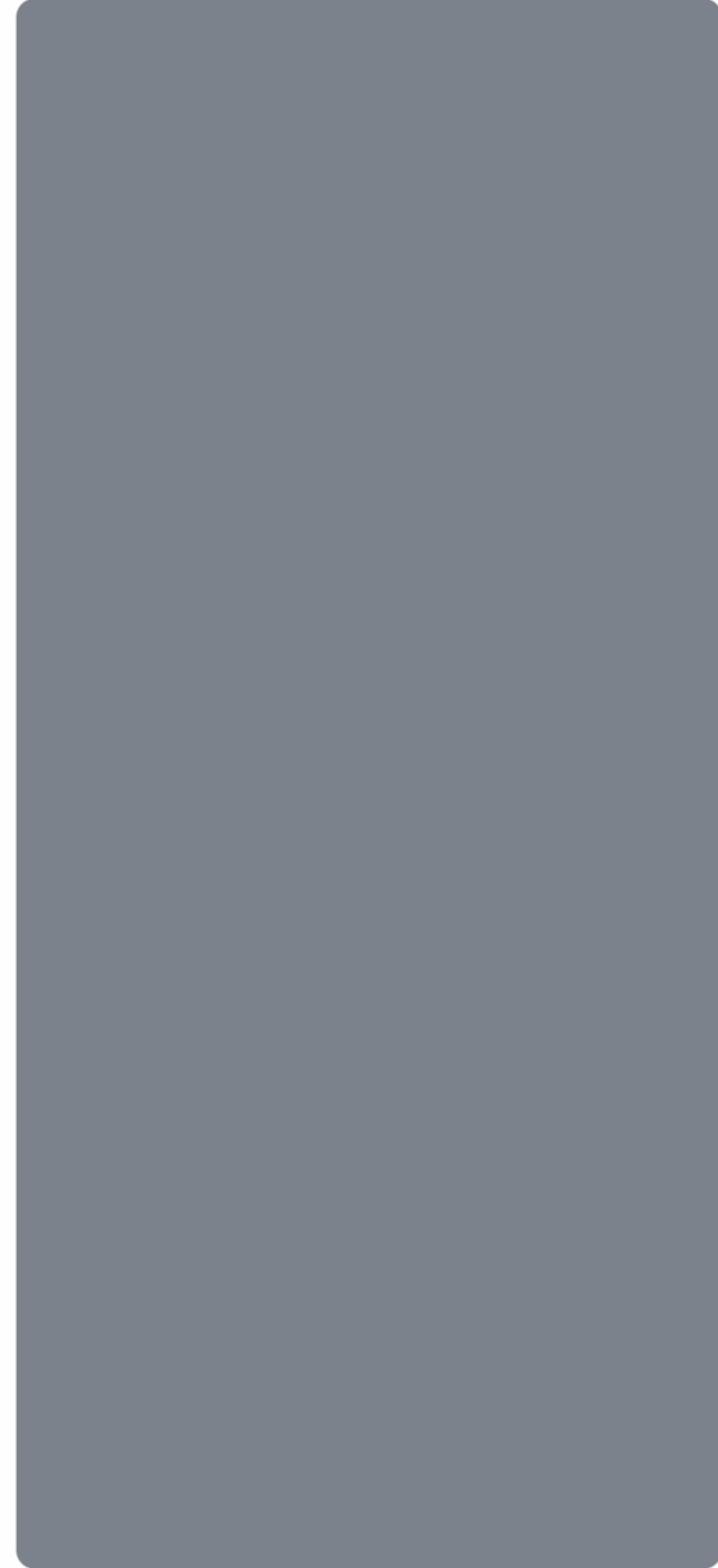

KO-ME-654

Acrylic
Brilliance



Elevate Interiors
with Acrylic Brilliance



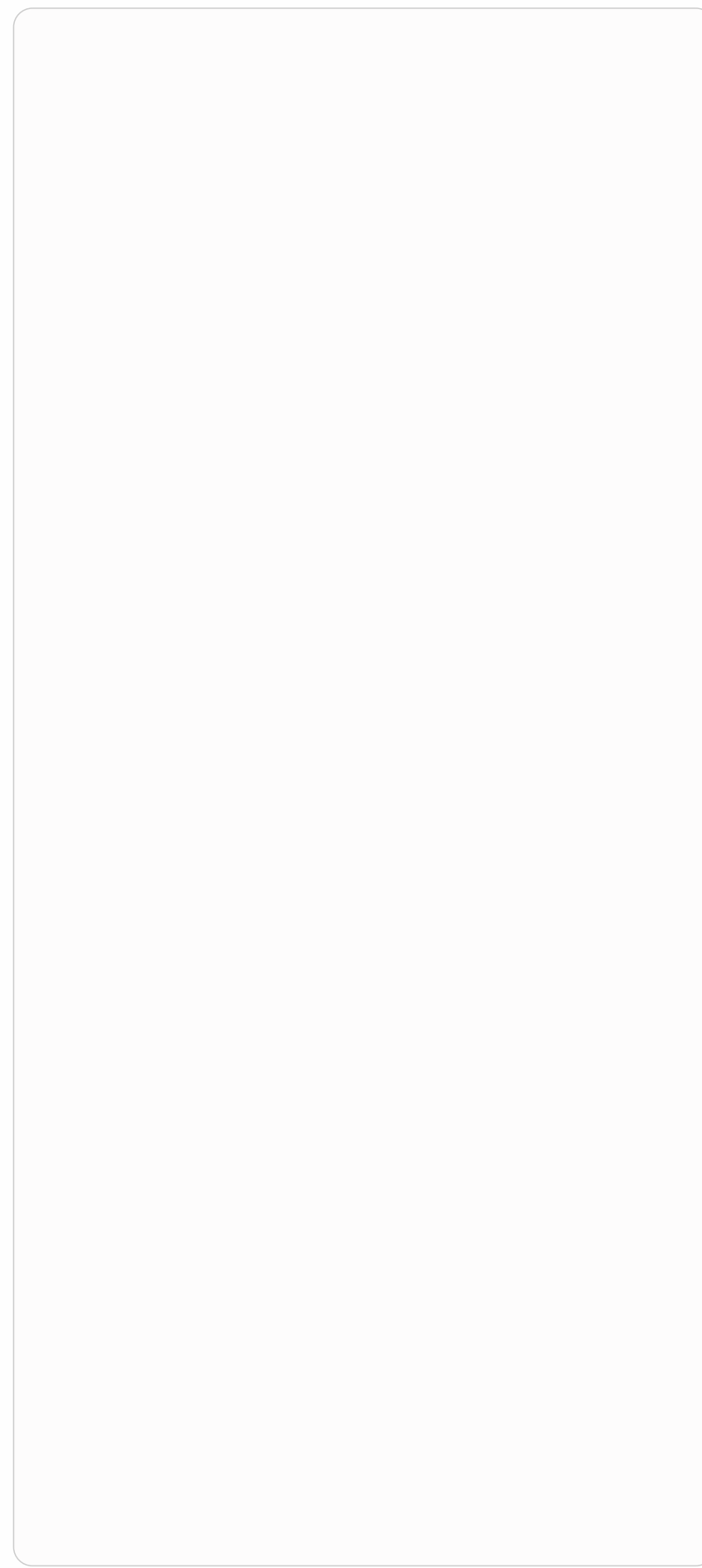

KO-MR-351

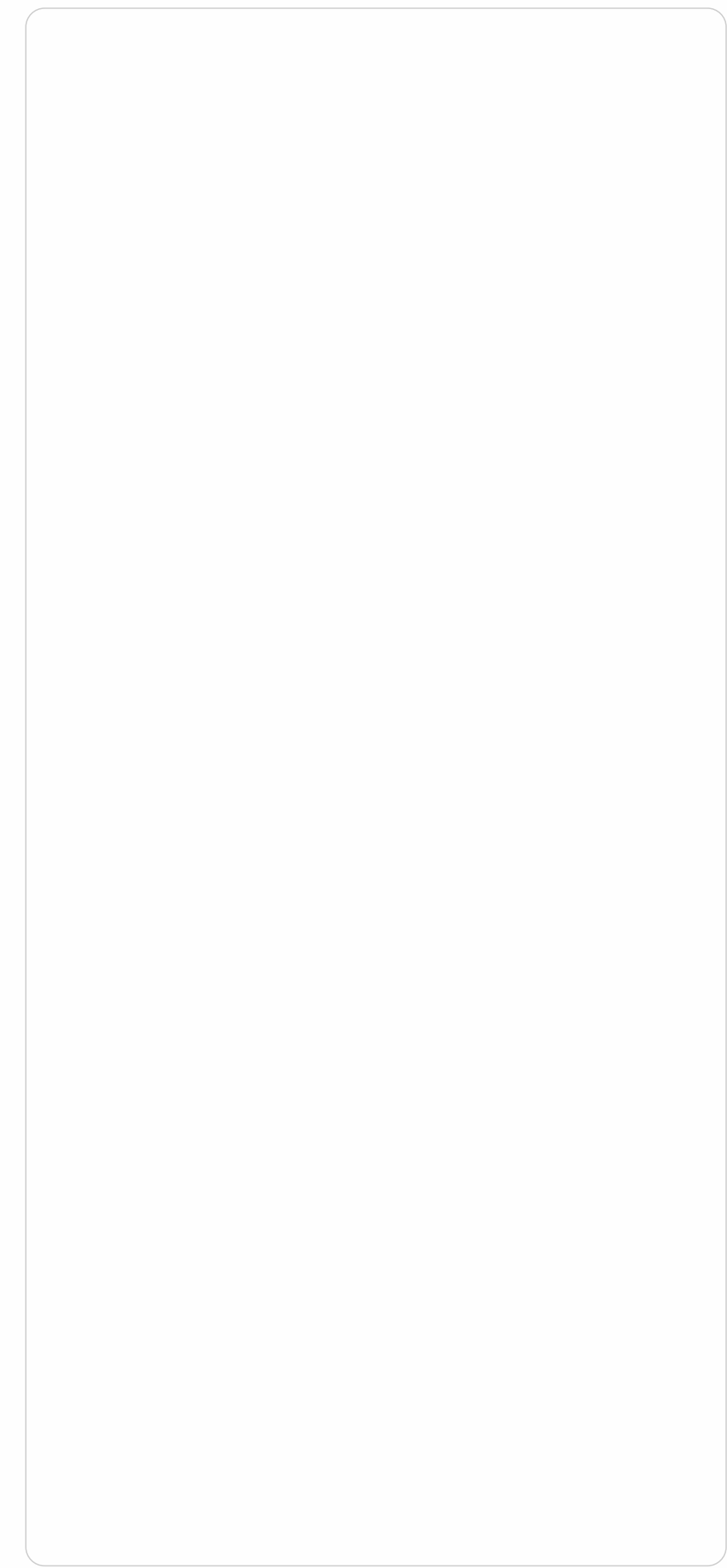

KO-MR-352

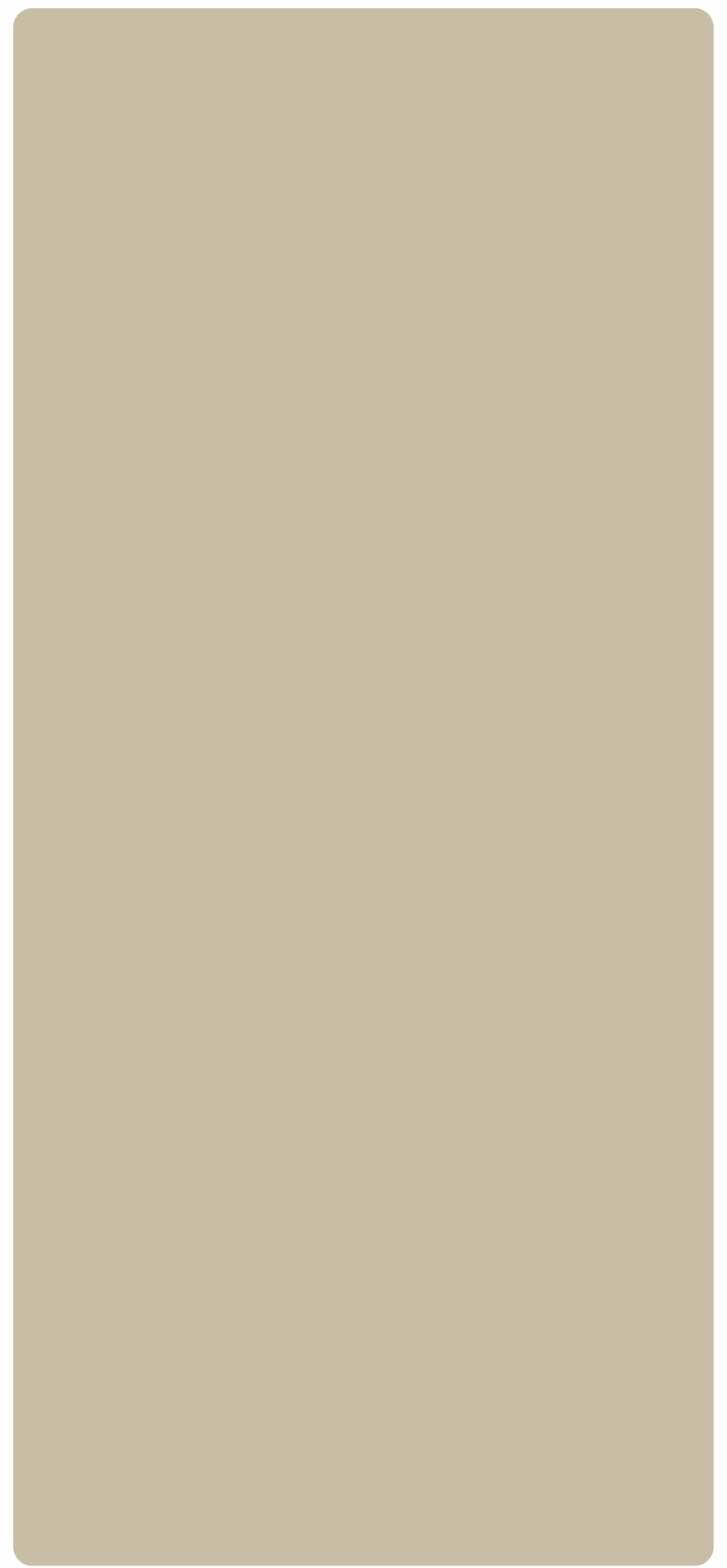

KO-MR-302

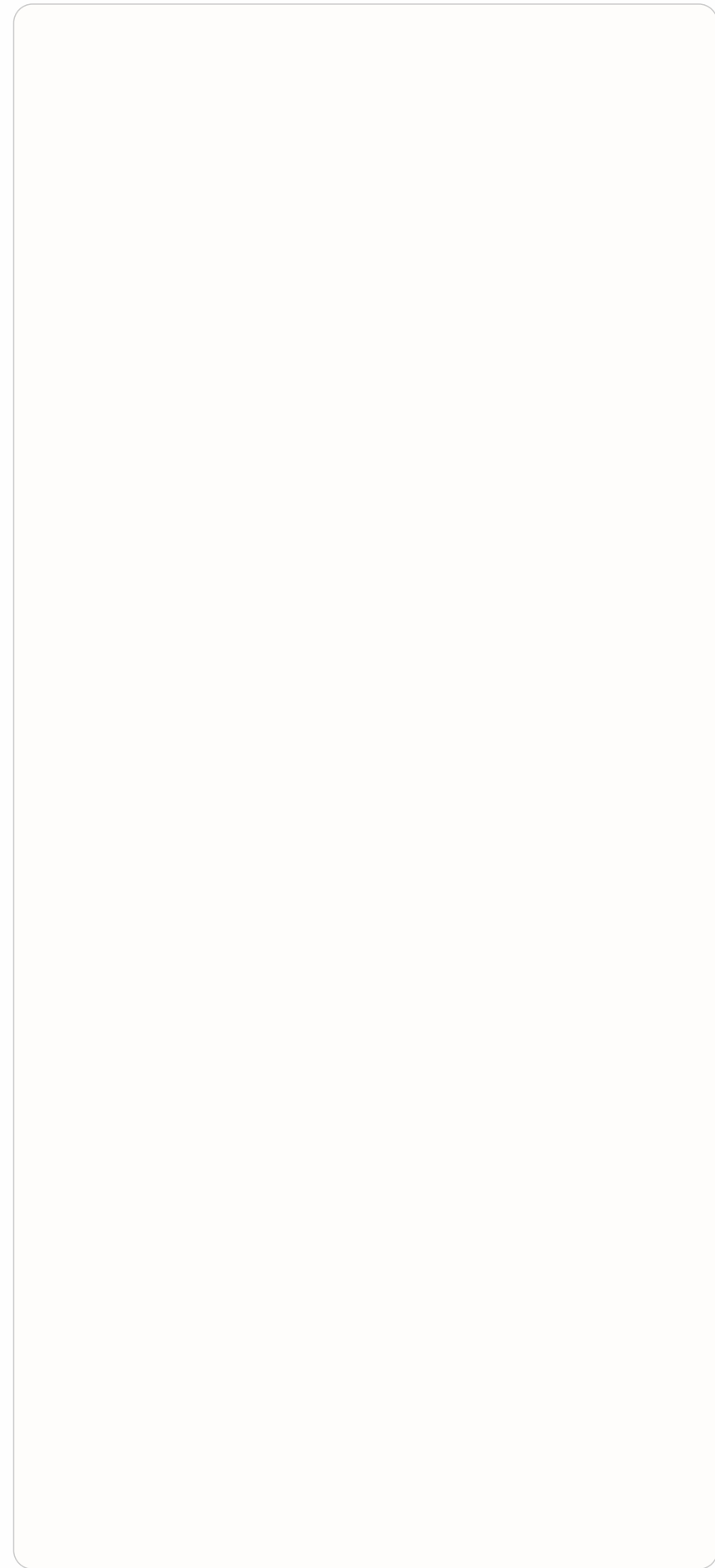

KO-MR-353

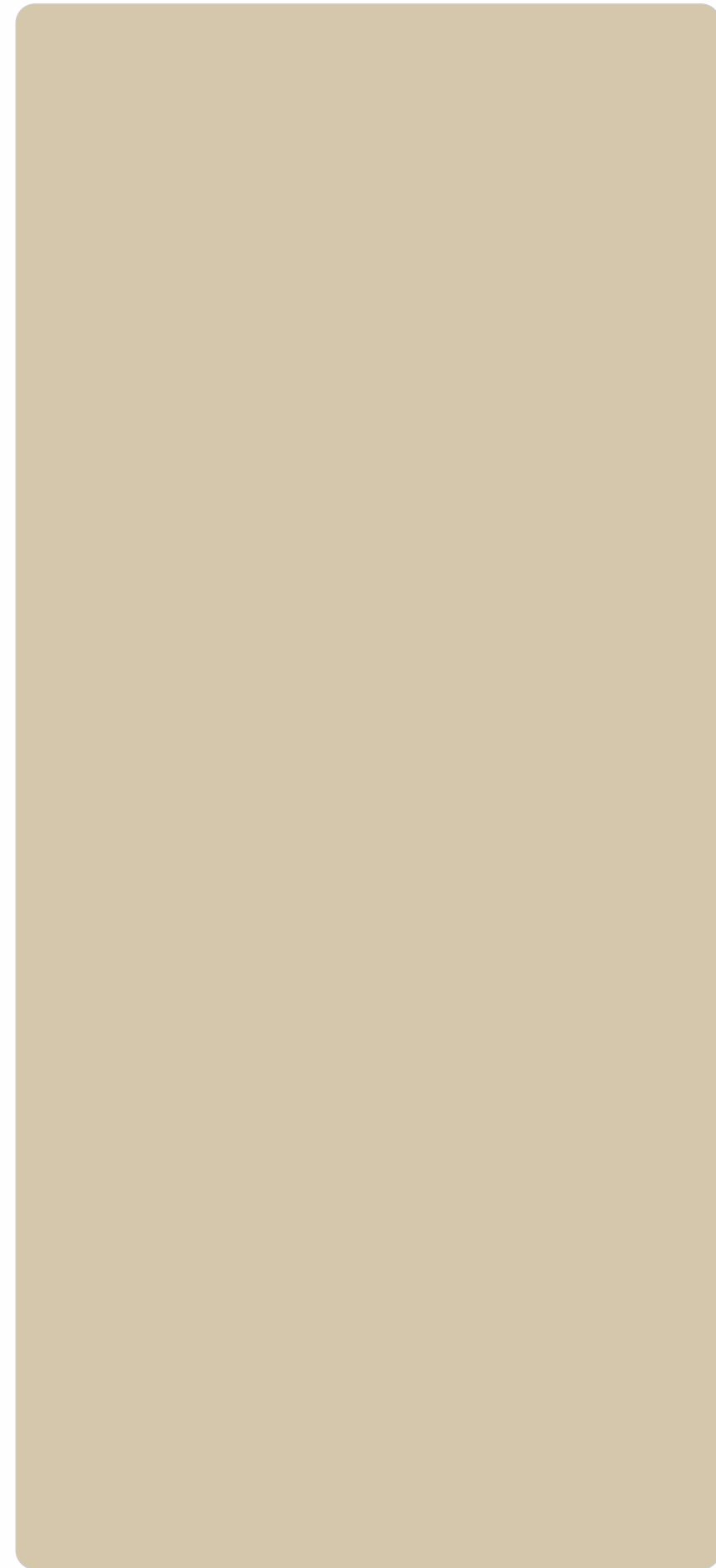

KO-MR-301

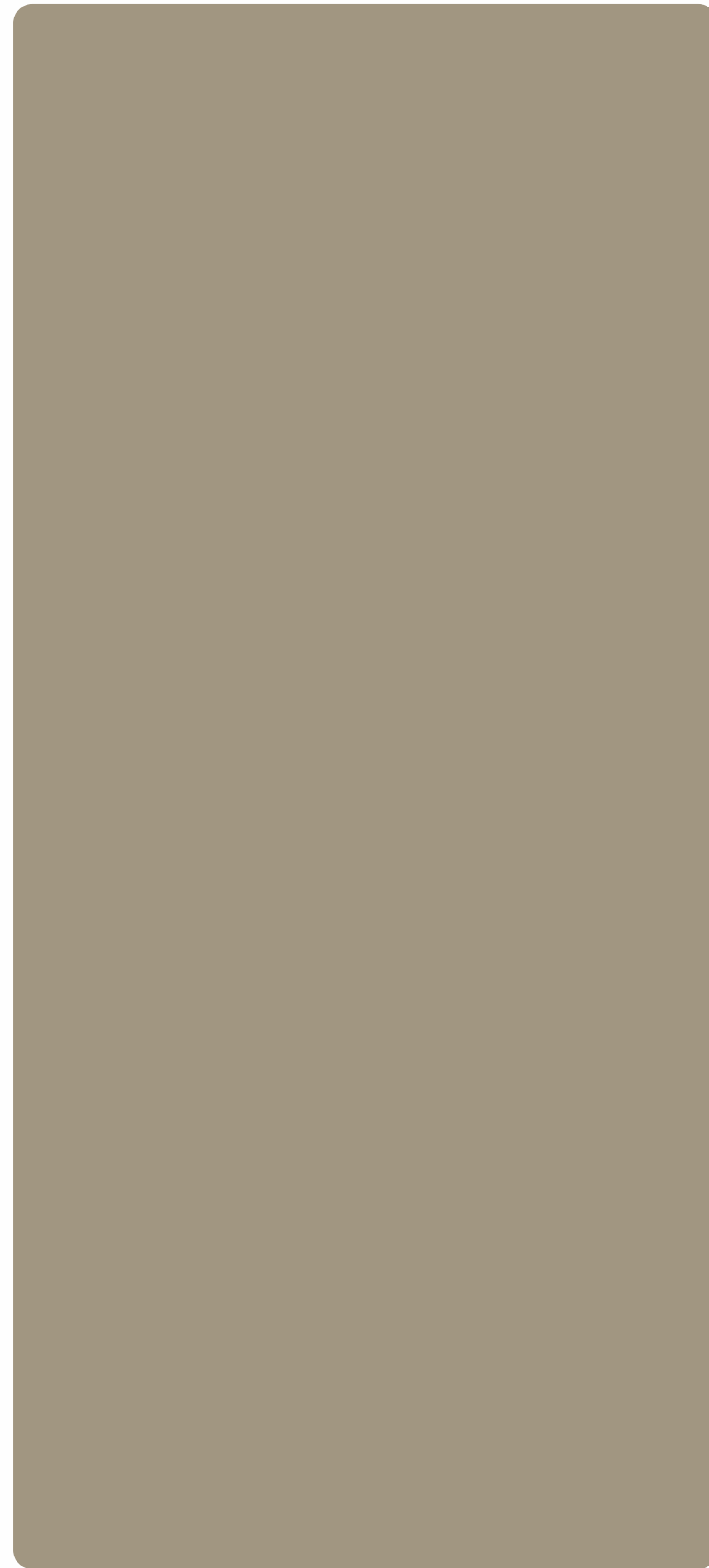

KO-MR-303



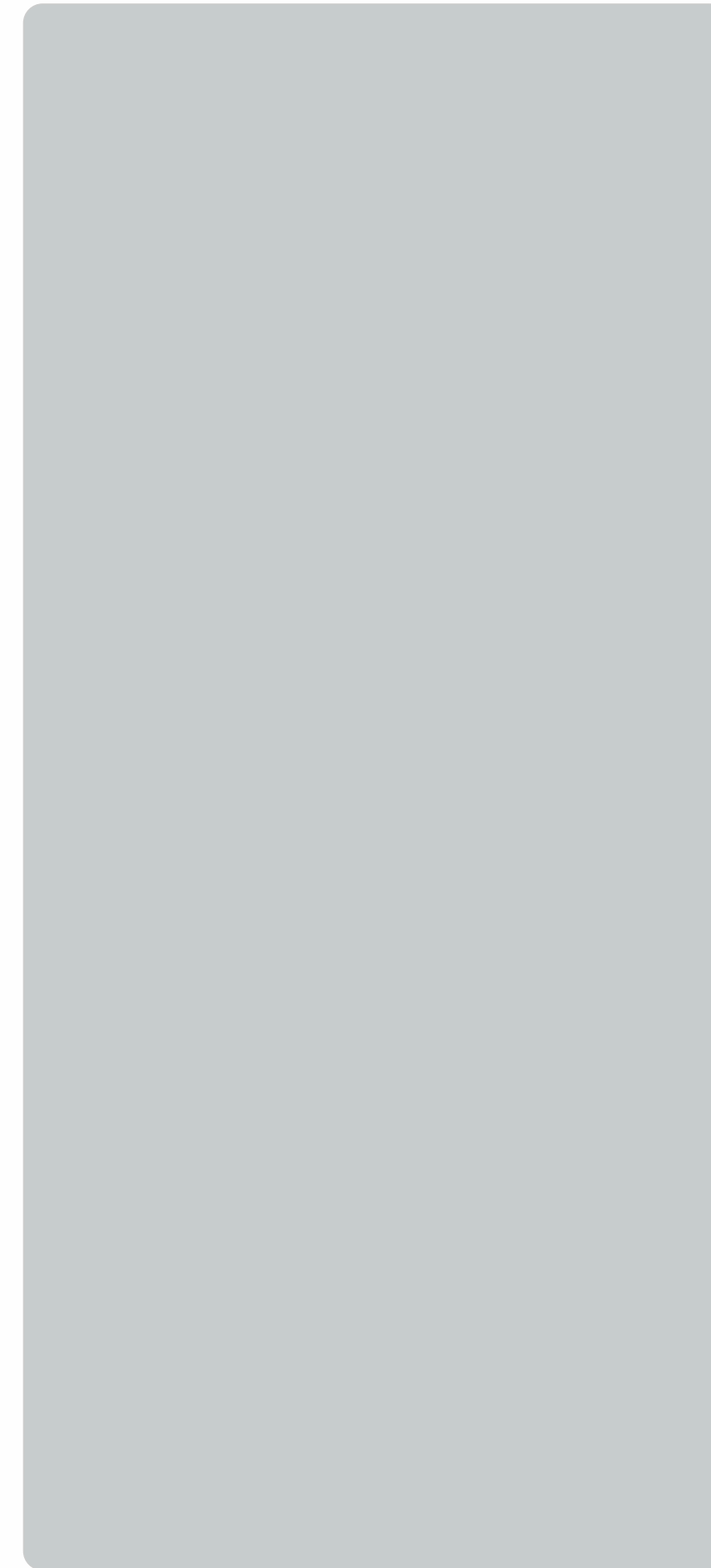

KO-MR-354



KO-MR-355

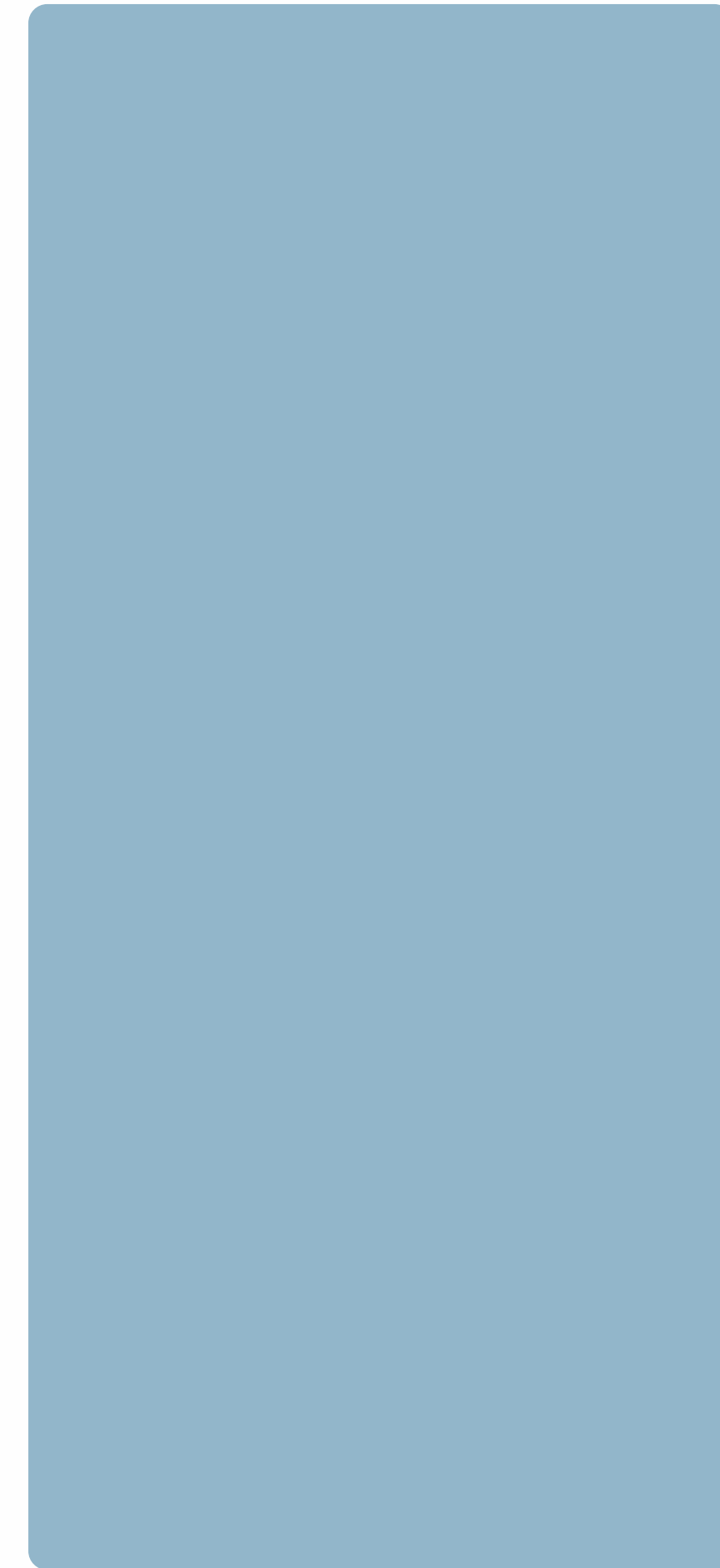

KO-MR-356

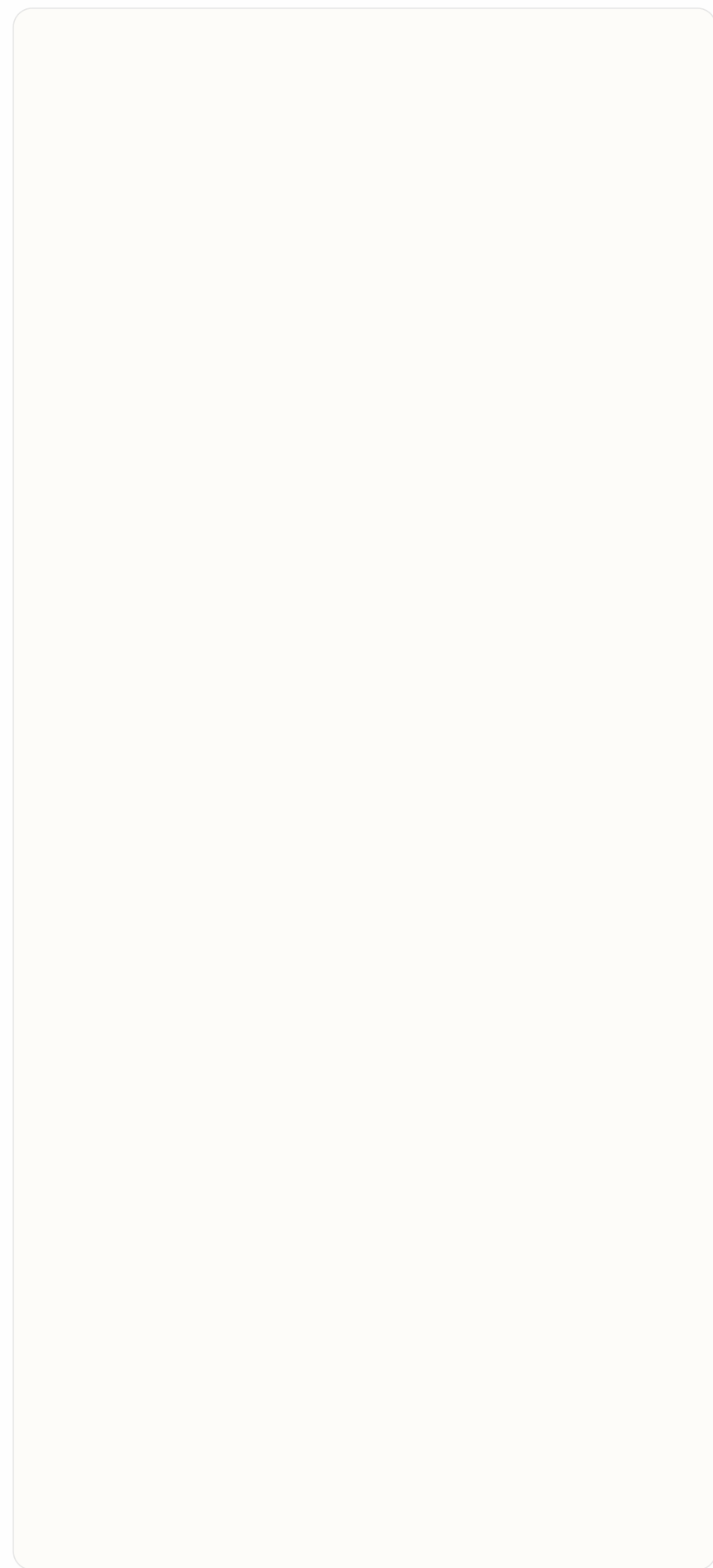
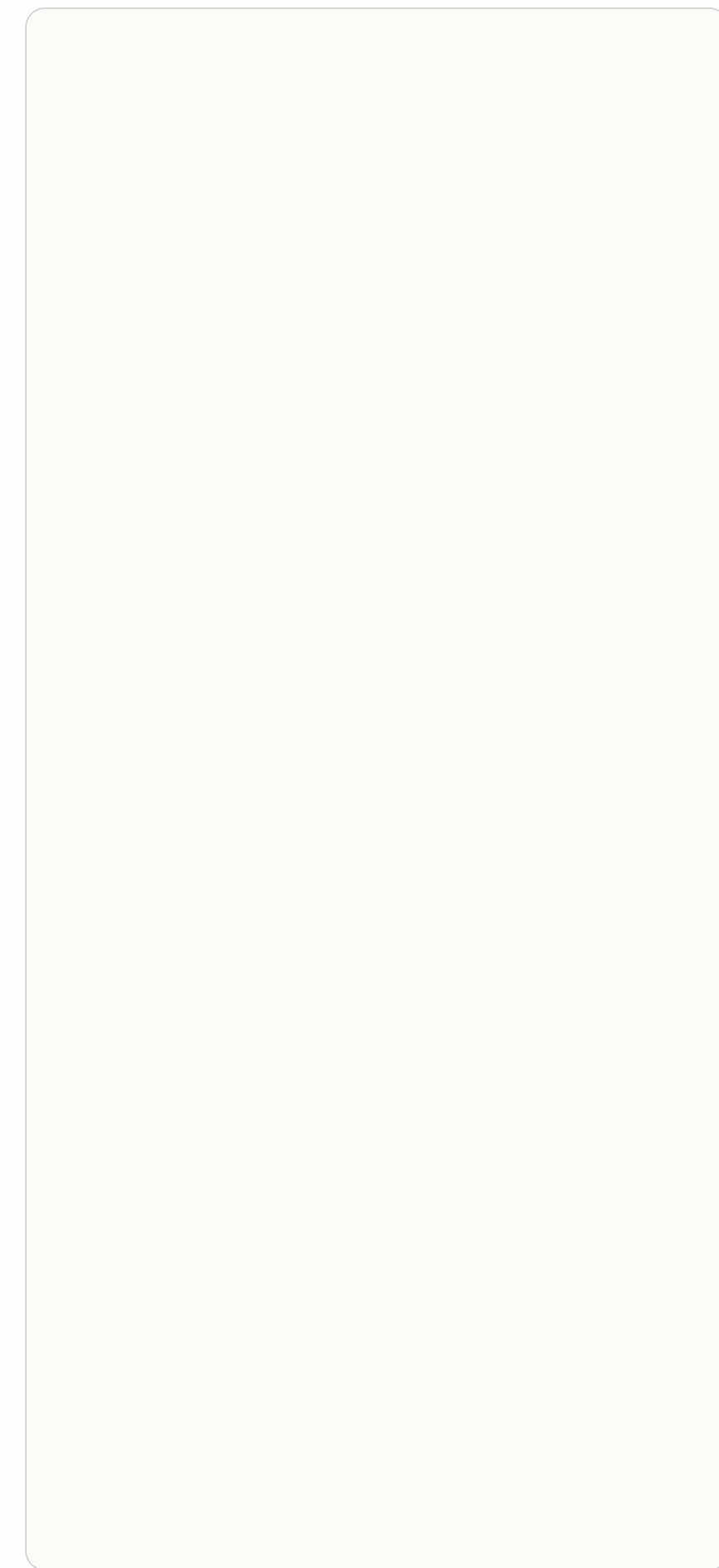
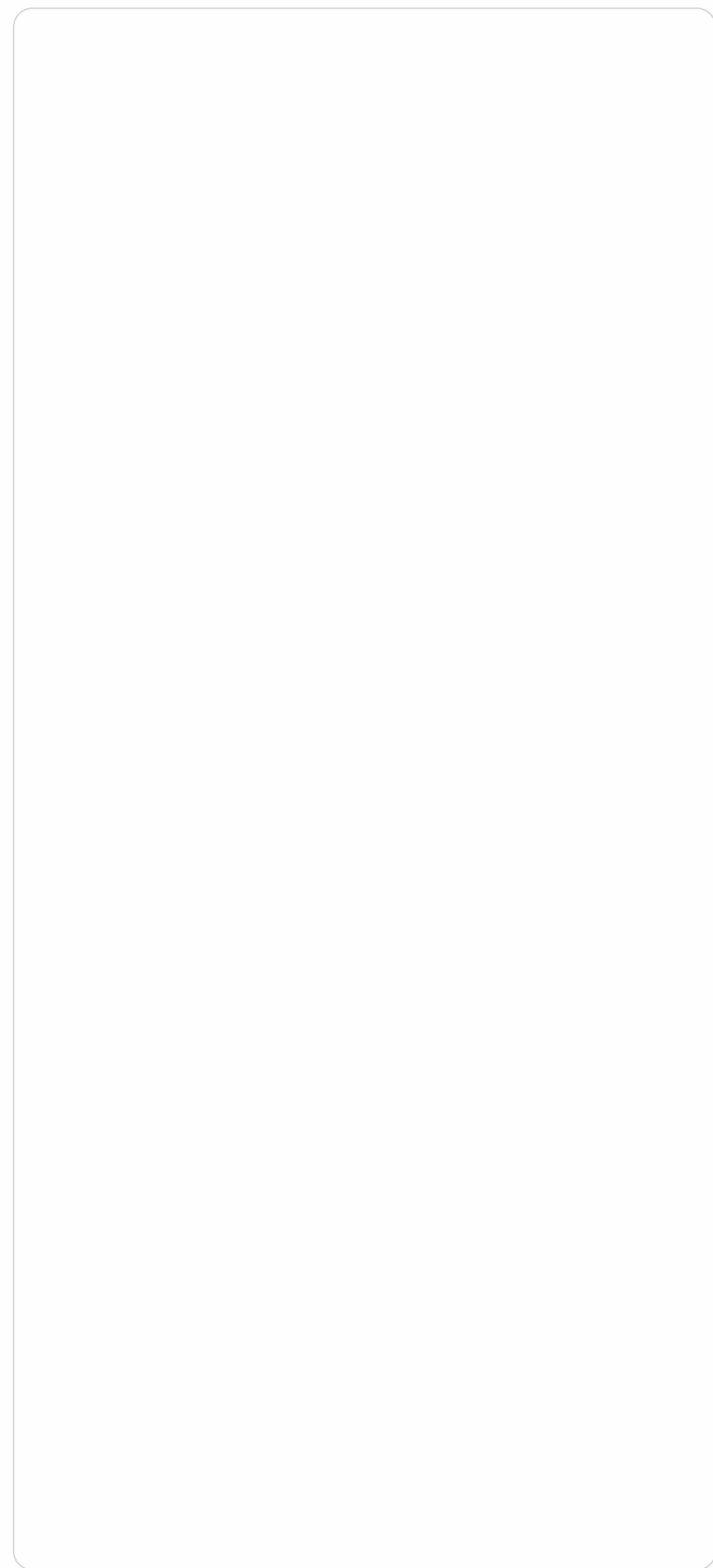

KO-MT-451

KO-MT-402

KO-MT-403



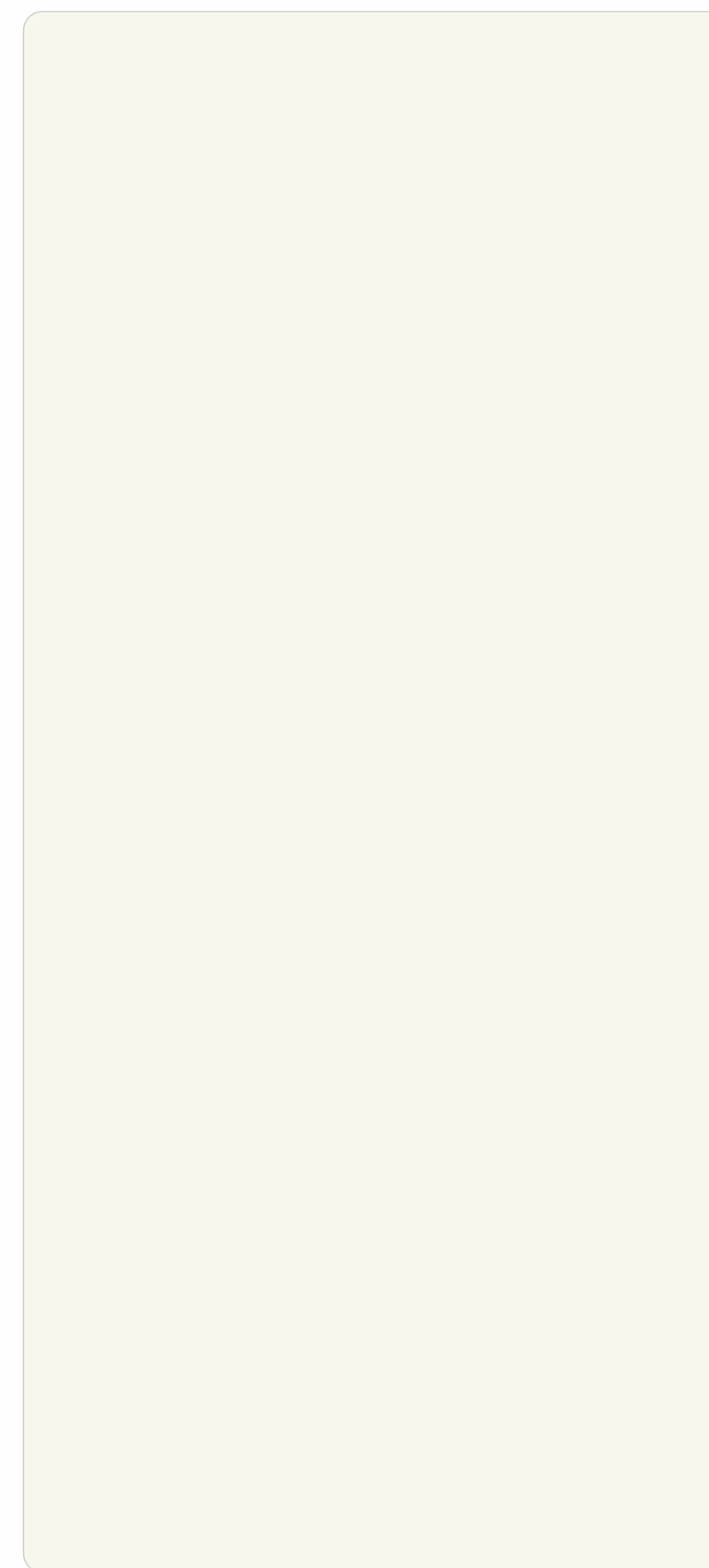

KO-MT-404

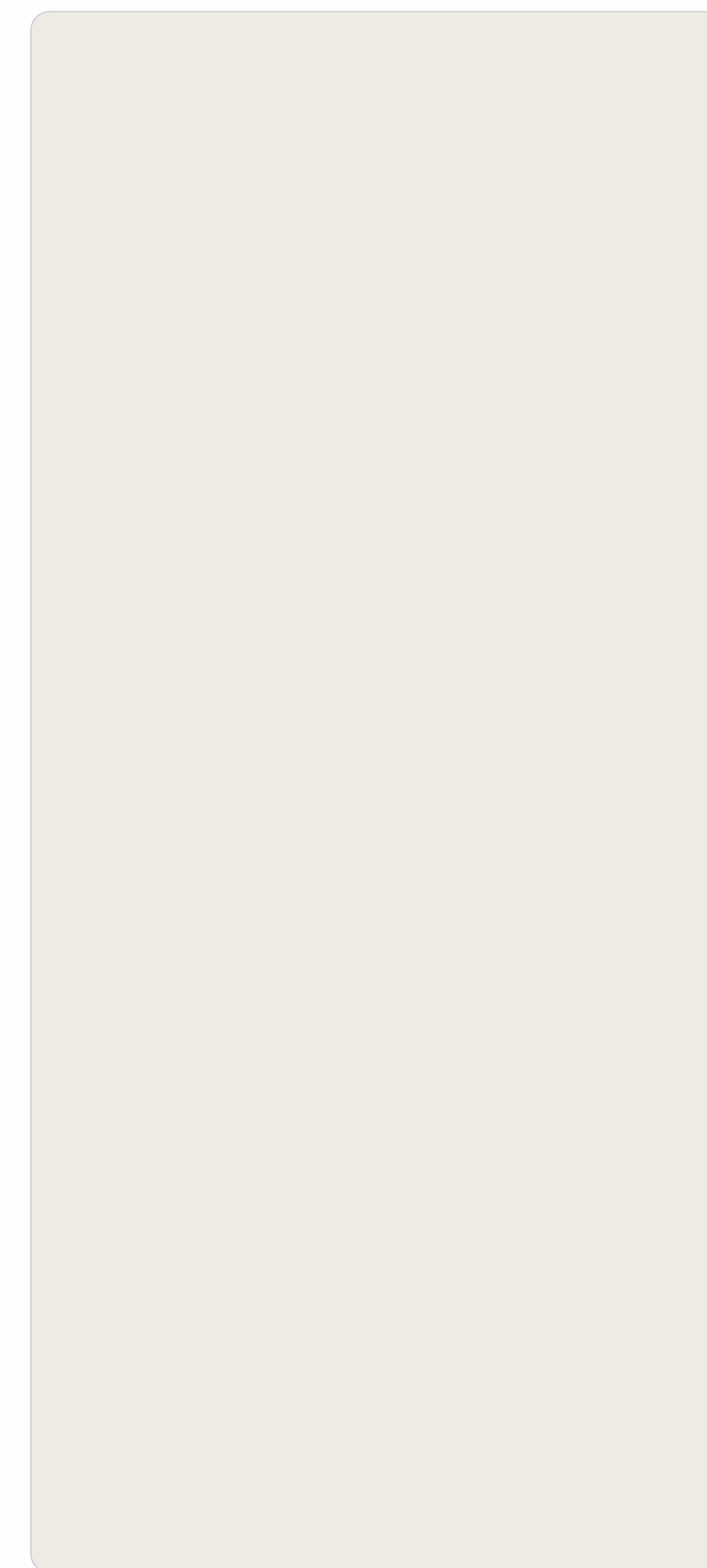

KO-MT-457

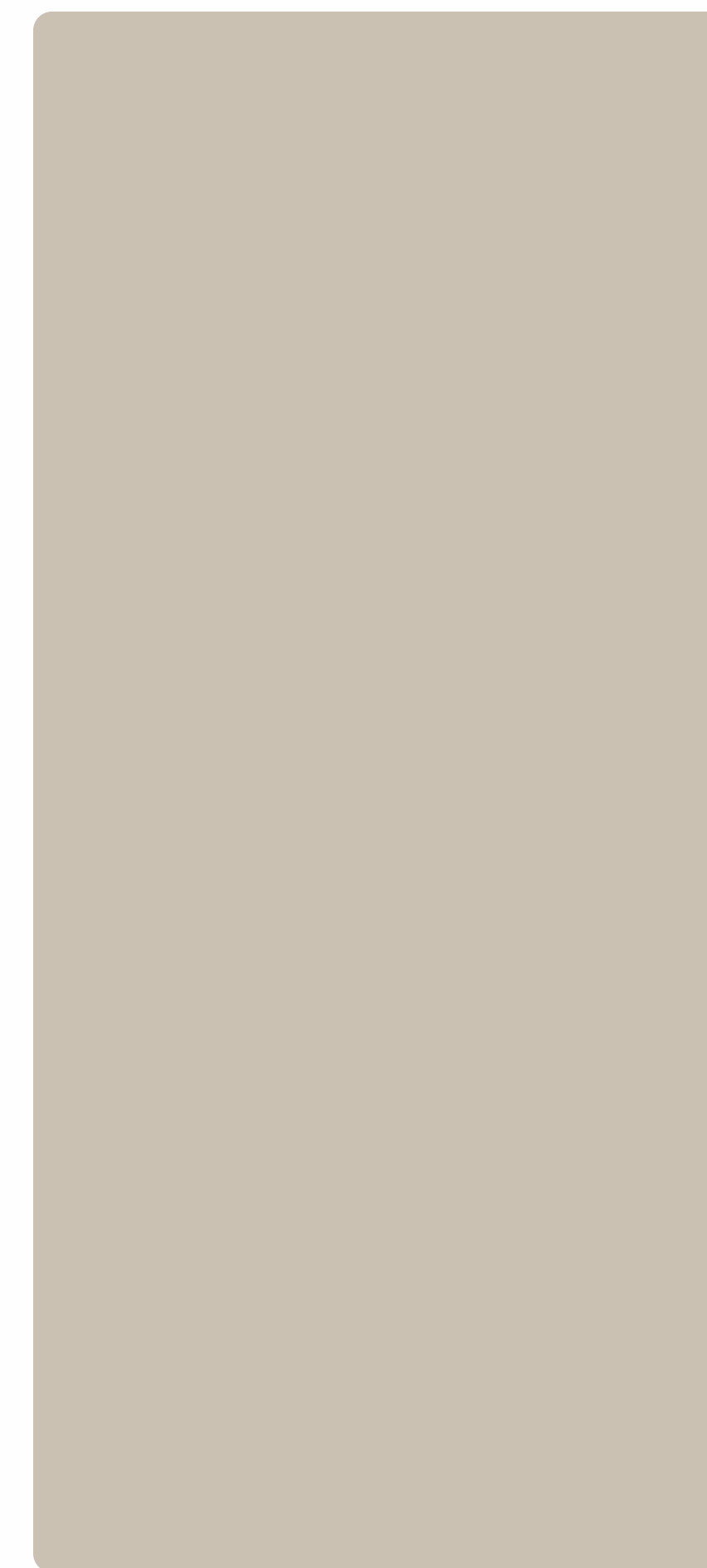

KO-MT-453

**MATT
FINISH**

WELMICA
LAMINATES

KOREAN Sheet
CORE ACRYLIC LAMINATE

Engineered Precision
for Timeless Interiors.

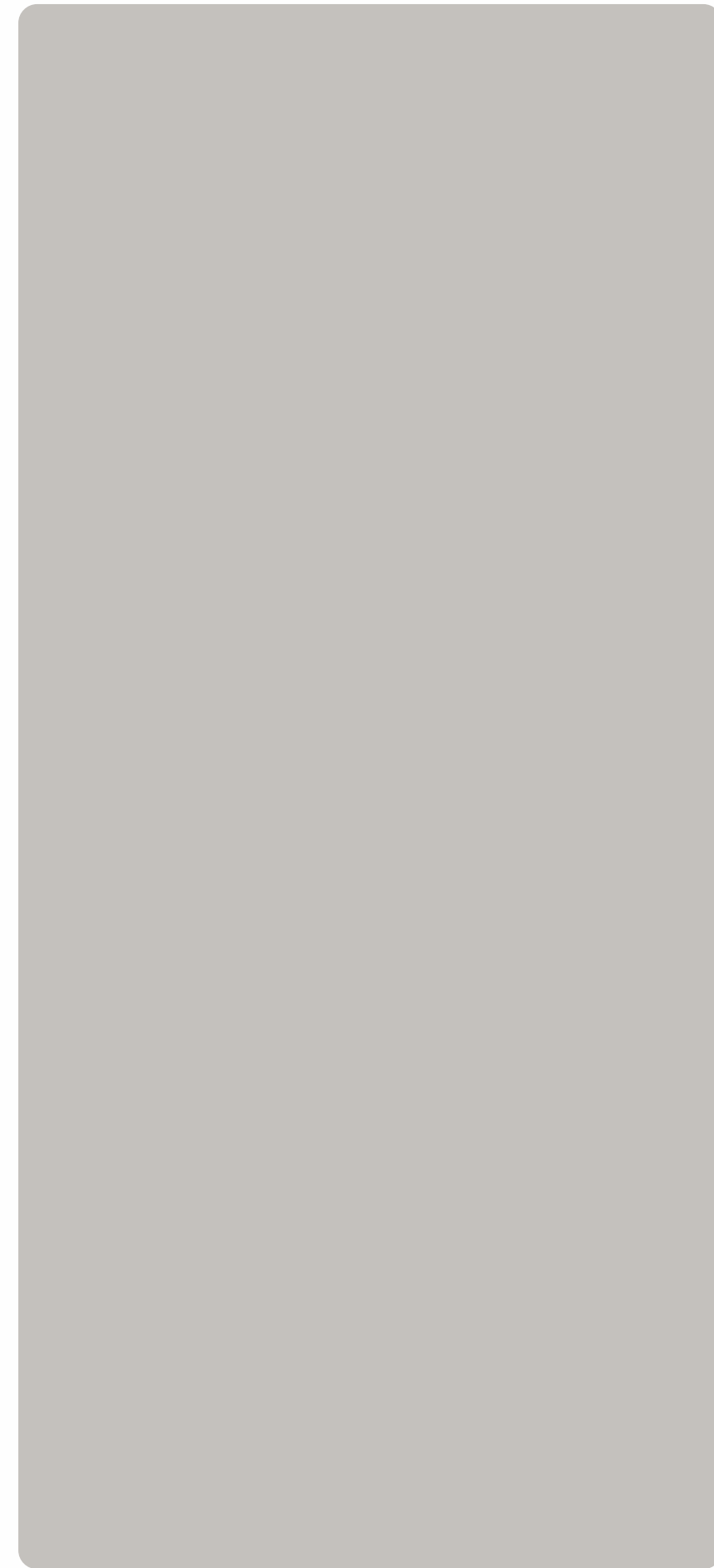
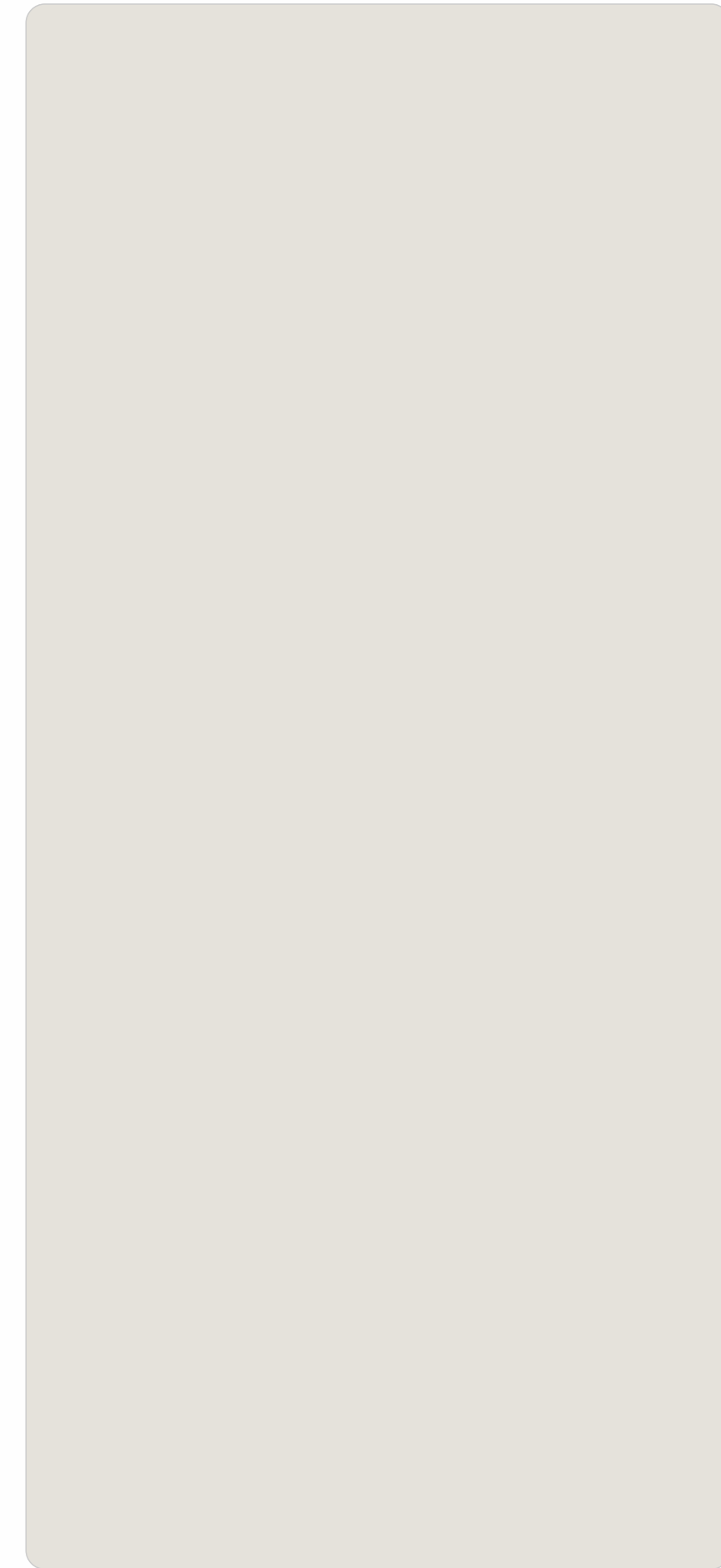
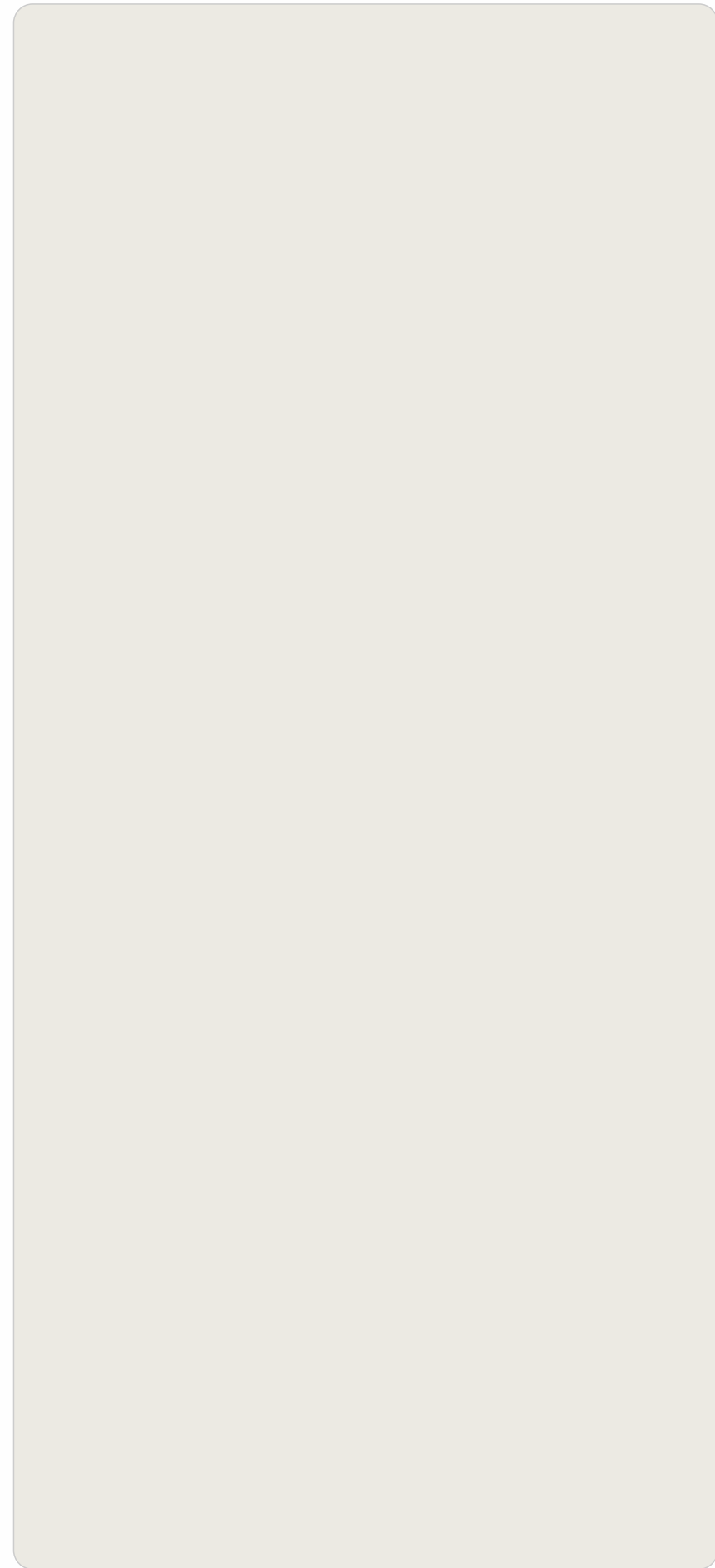

KO-MT-454

KO-MT-456

KO-MT-455



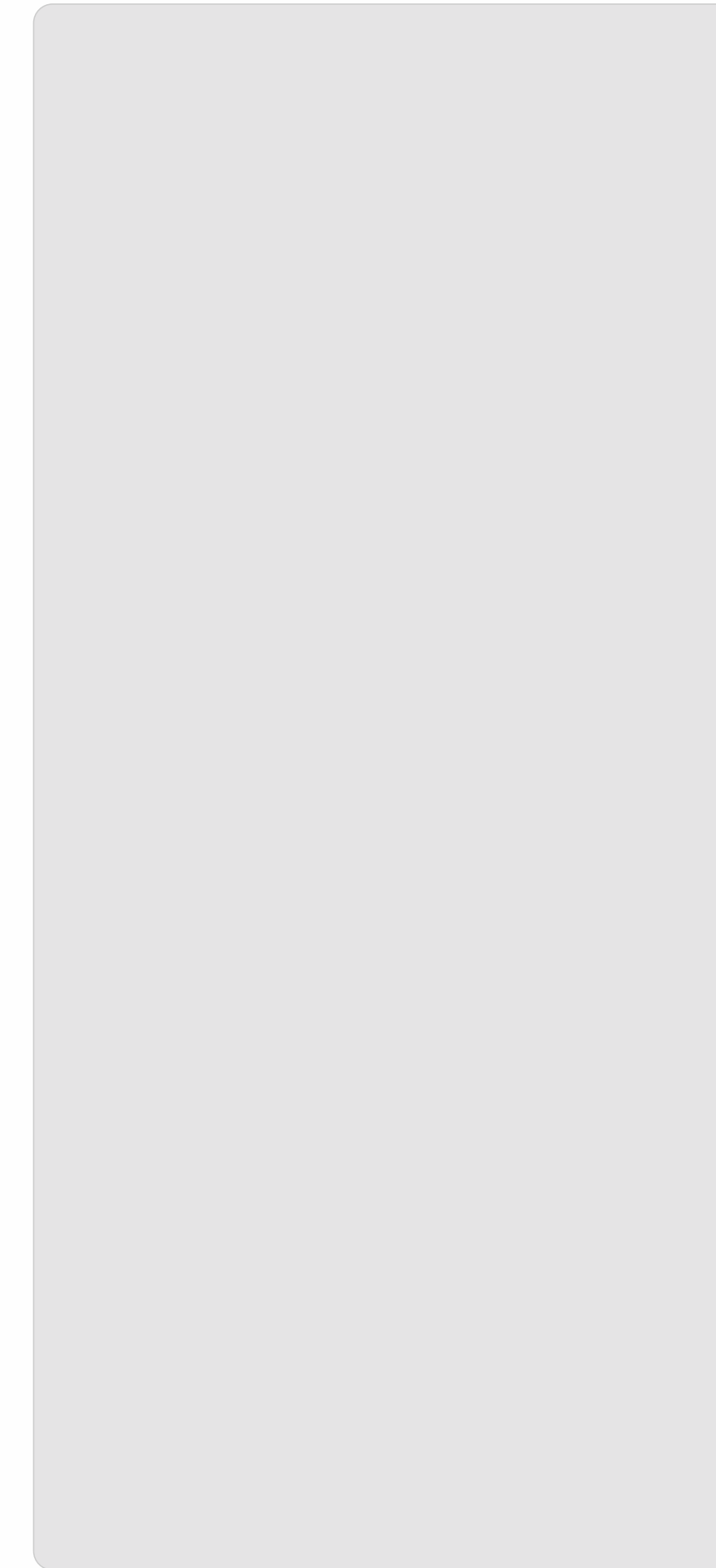

KO-MT-407

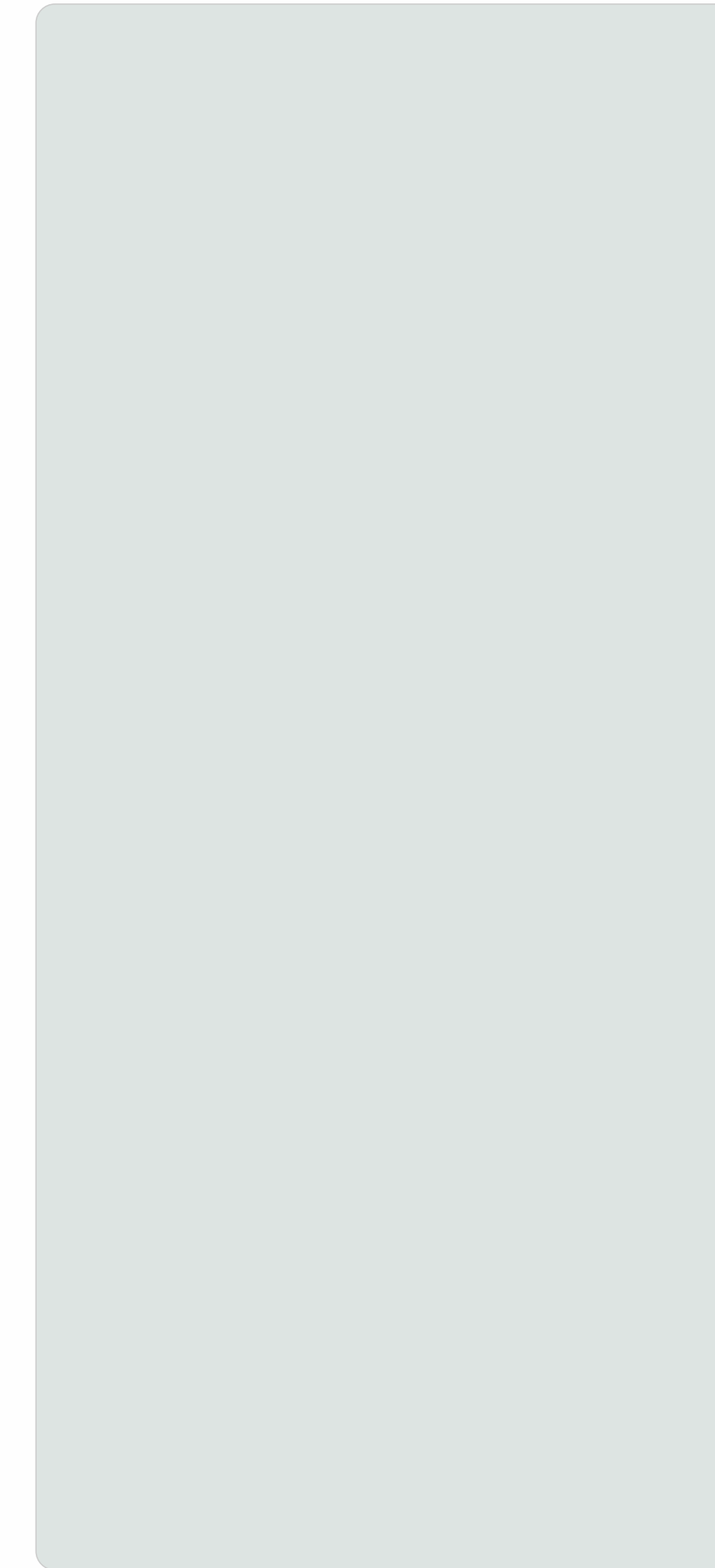

KO-MT-411

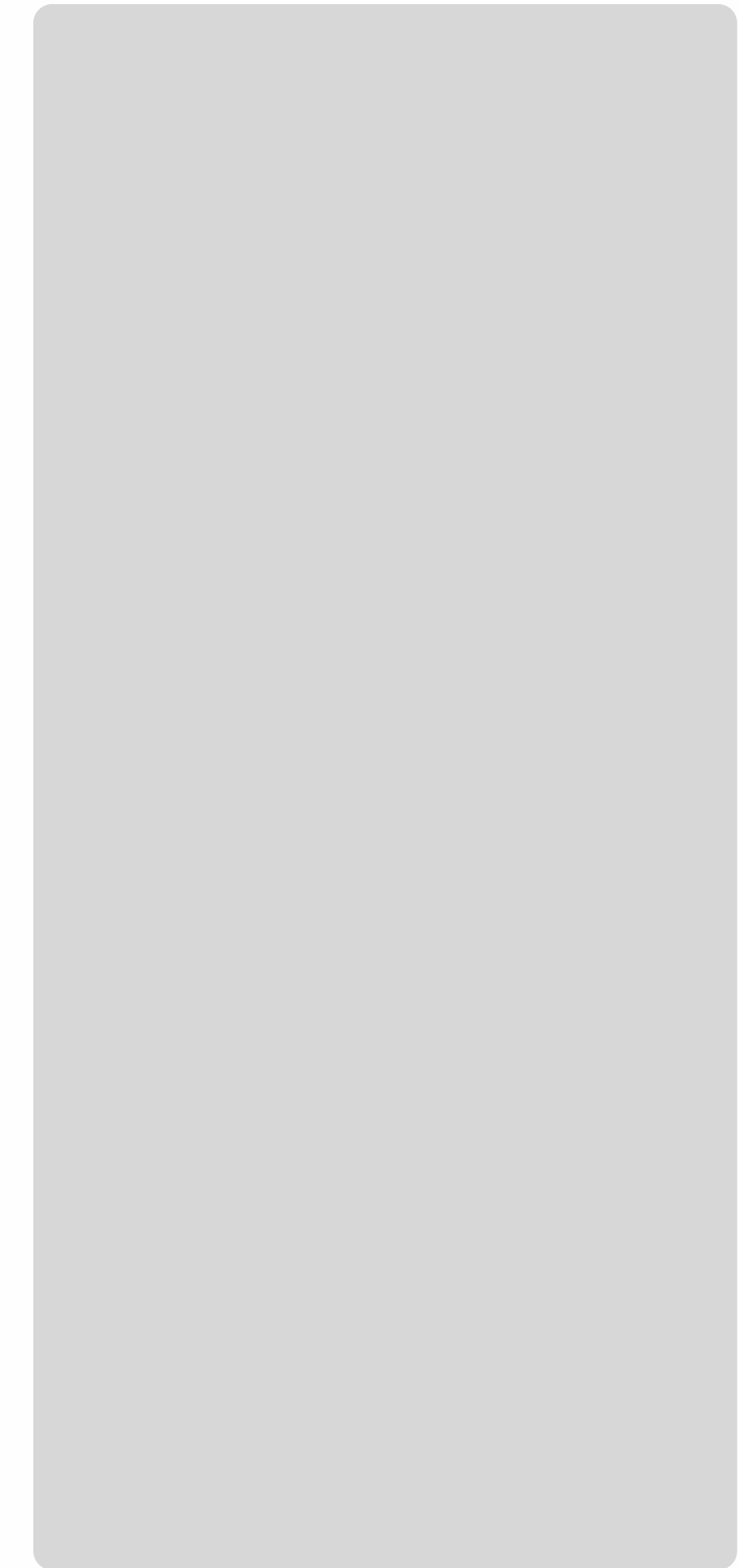

KO-MT-408

**MATT
FINISH**

WELMICA
LAMINATES

KOREAN Sheet
CORE ACRYLIC LAMINATE

The Future of Surfaces,
Today.

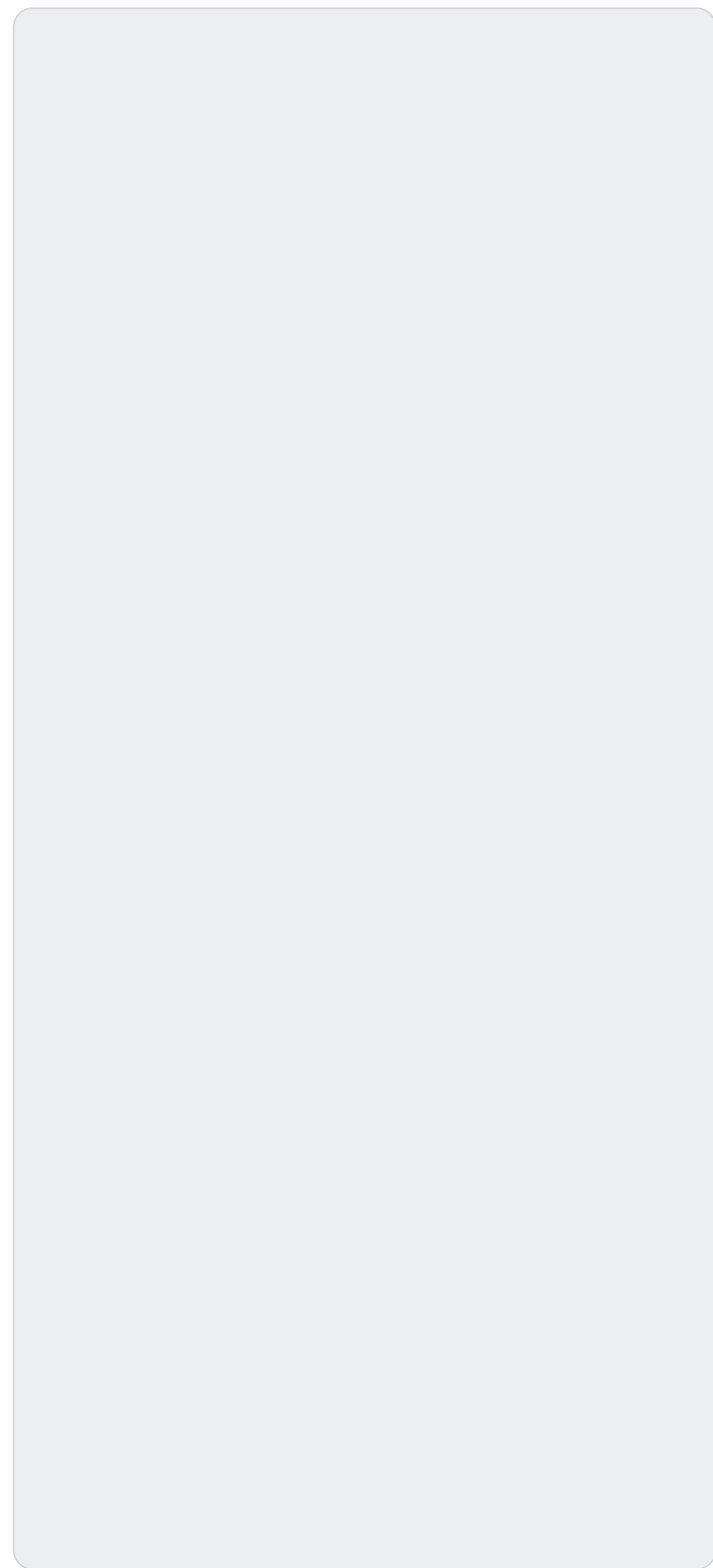

KO-MT-458

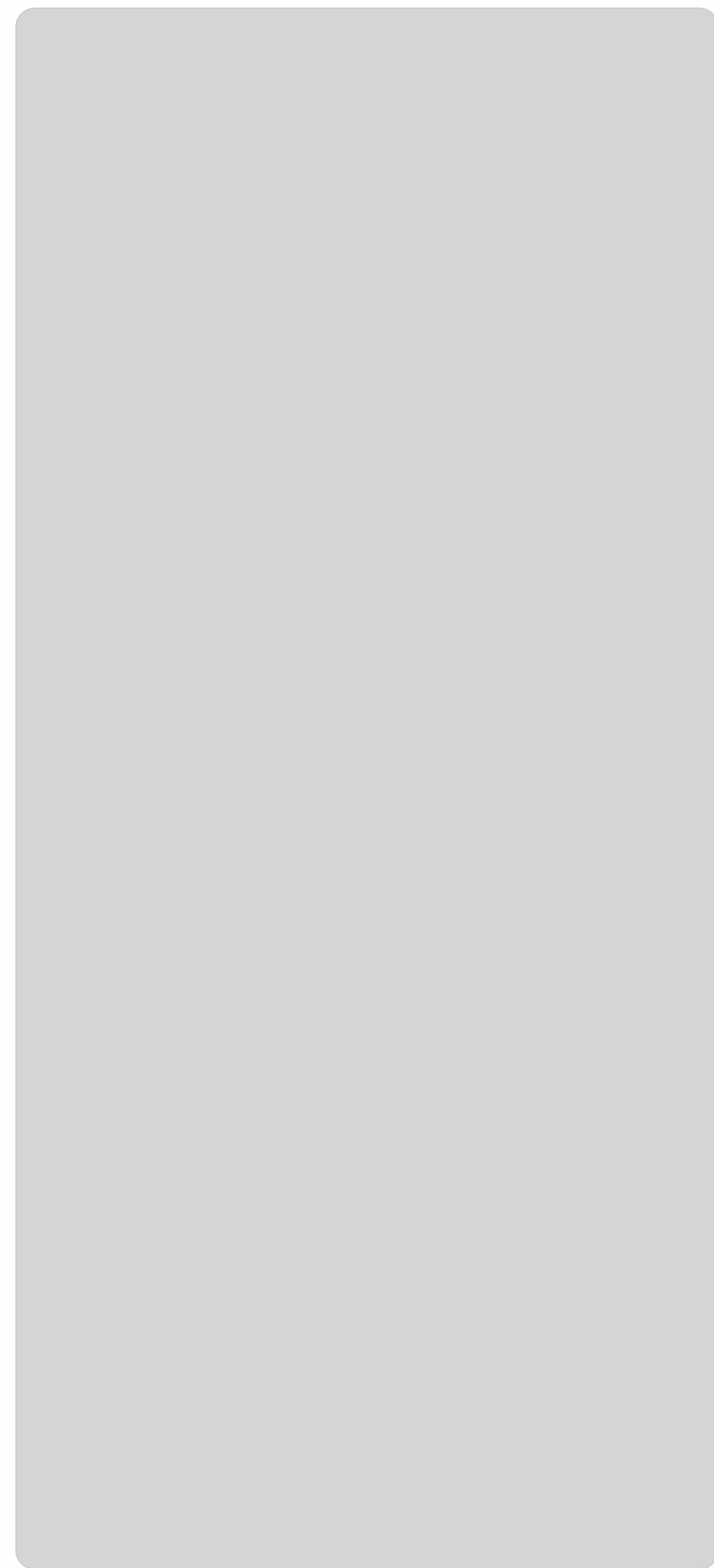

KO-MT-459



KO-MT-406



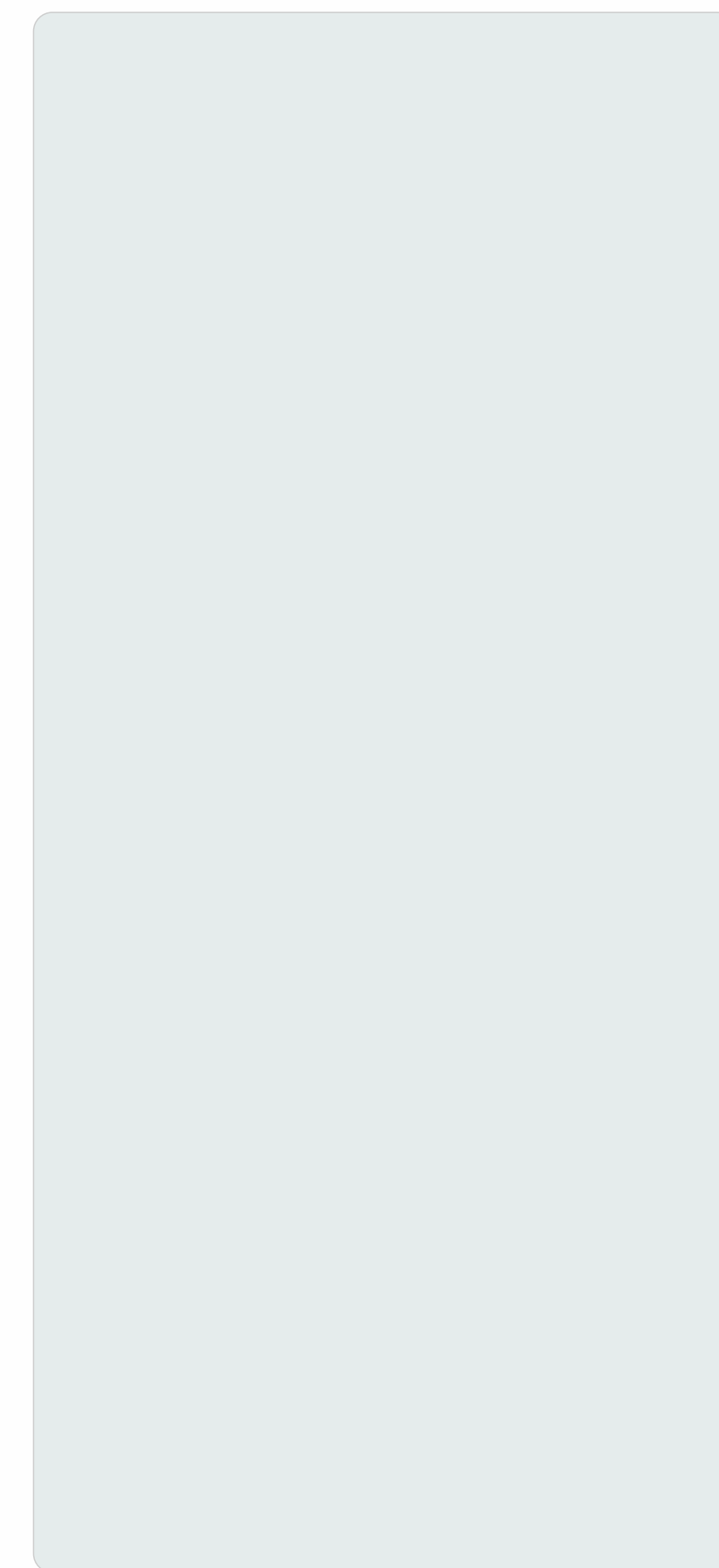

KO-MT-412



KO-MT-409



KO-MT-410

**MATT
FINISH**

WELMICA
LAMINATES

KOREAN Sheet
CORE ACRYLIC LAMINATE

Redefining Modern Spaces
with Acrylic Excellence.

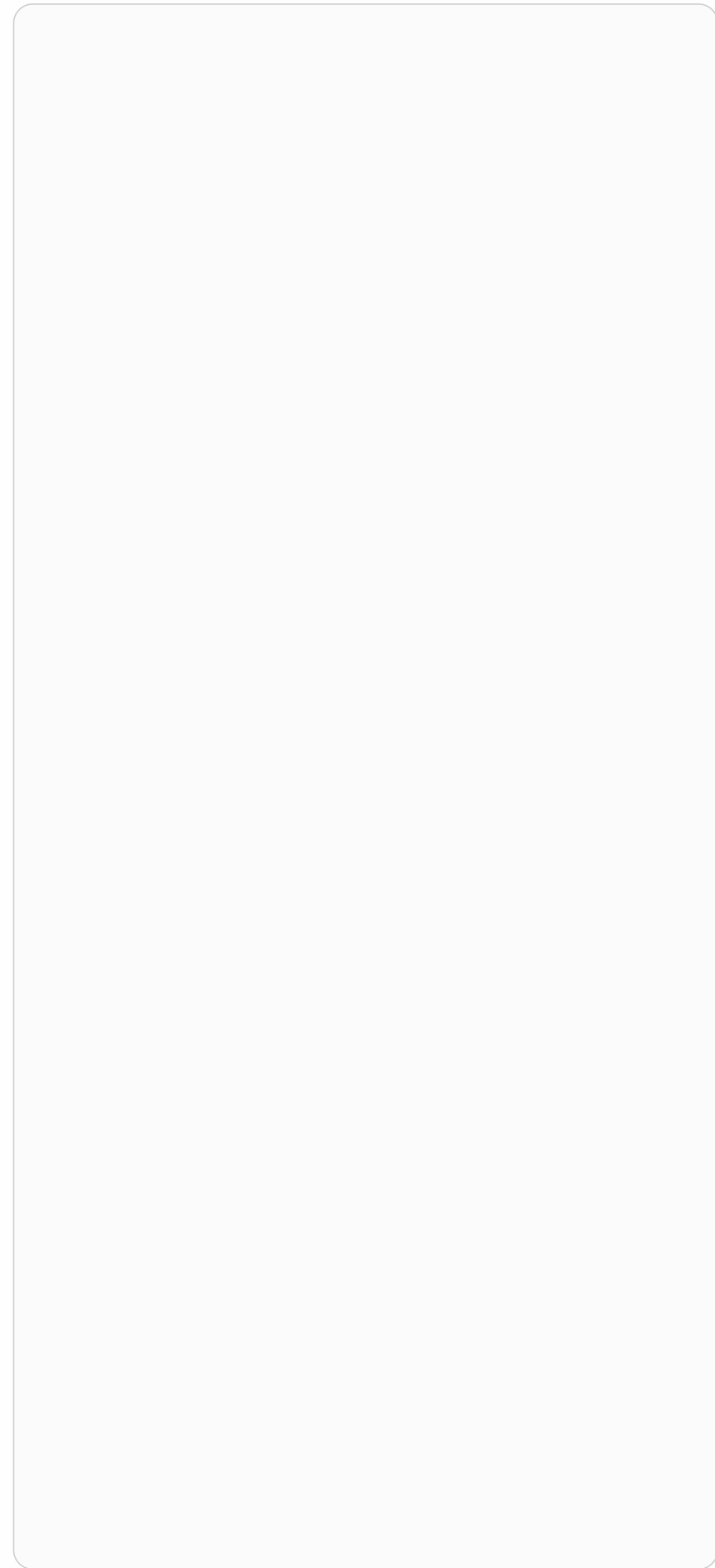

KO-MT-452

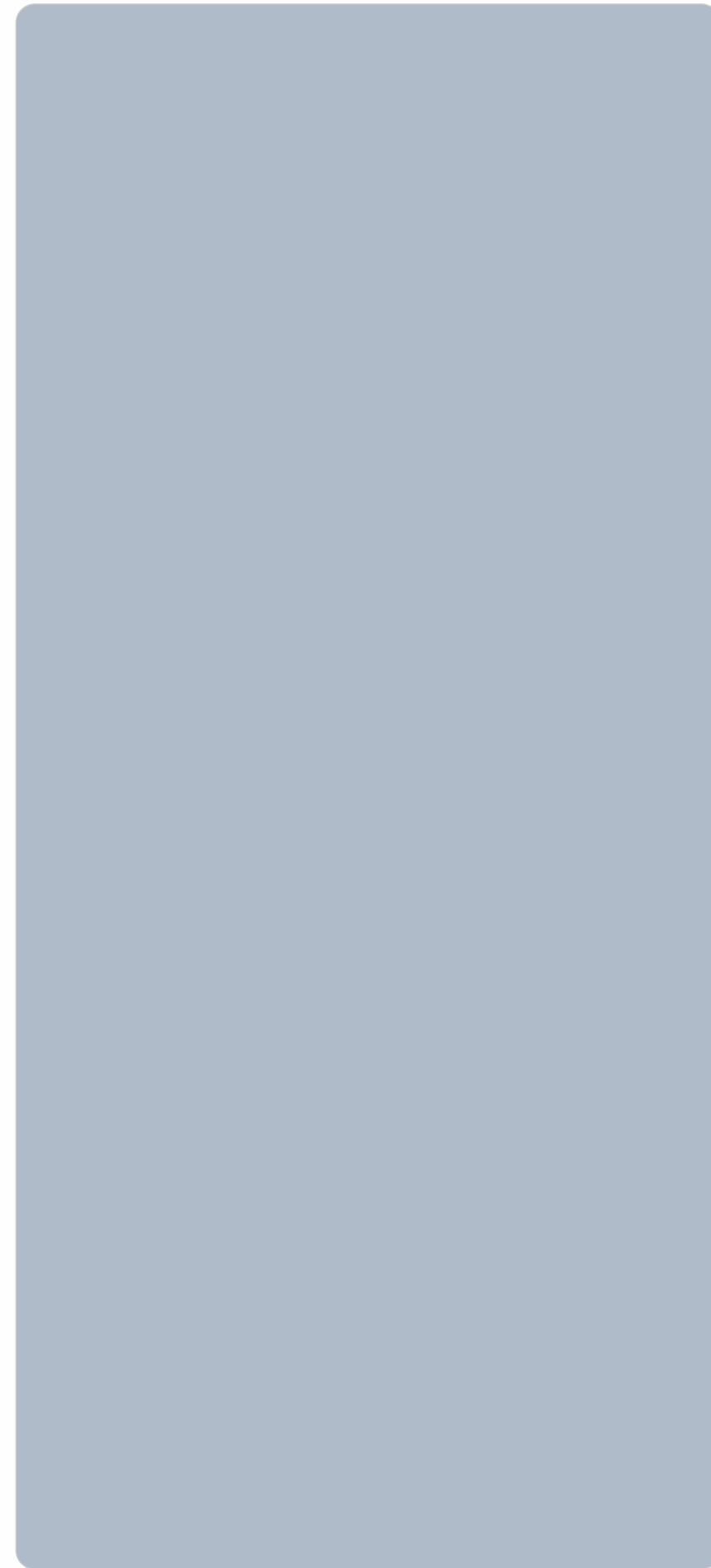

KO-MT-463

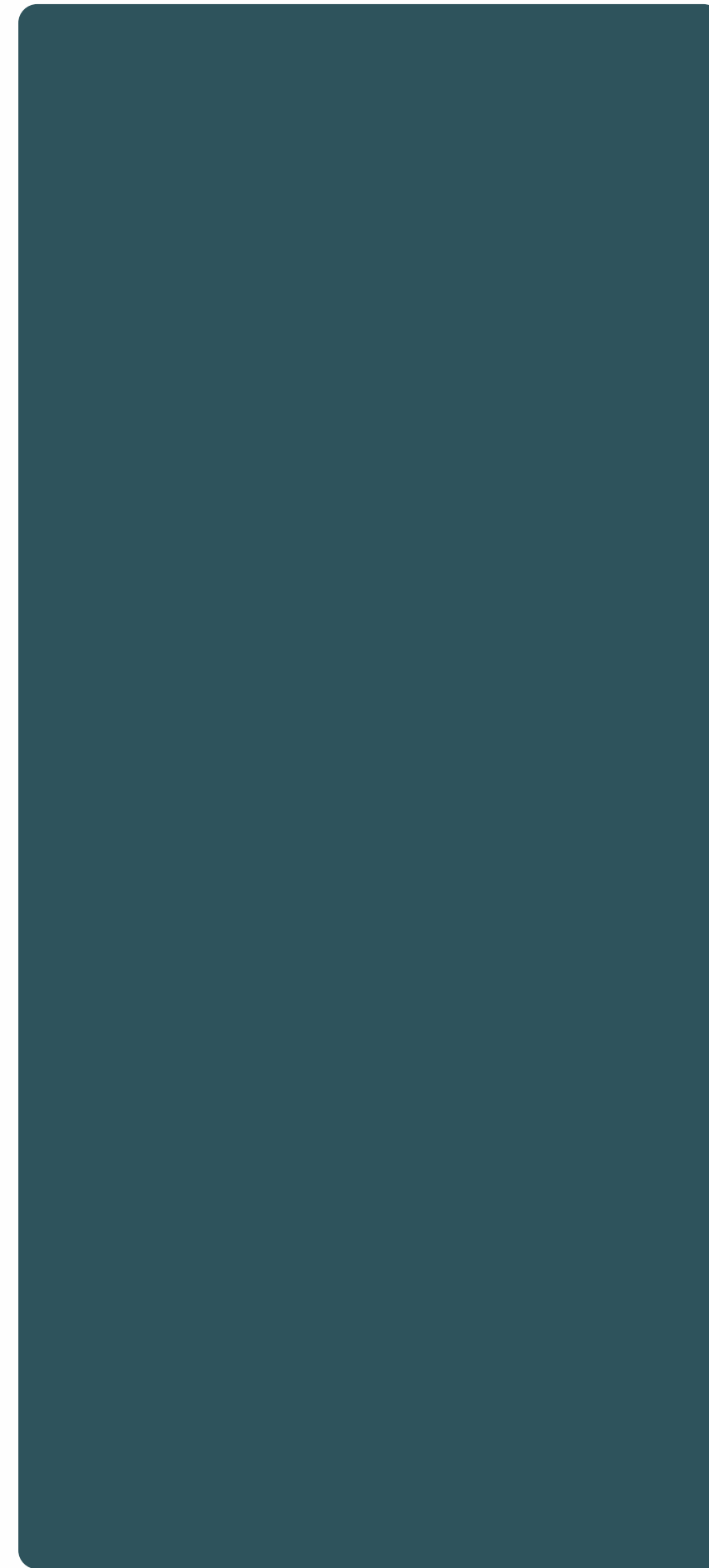

KO-MT-413



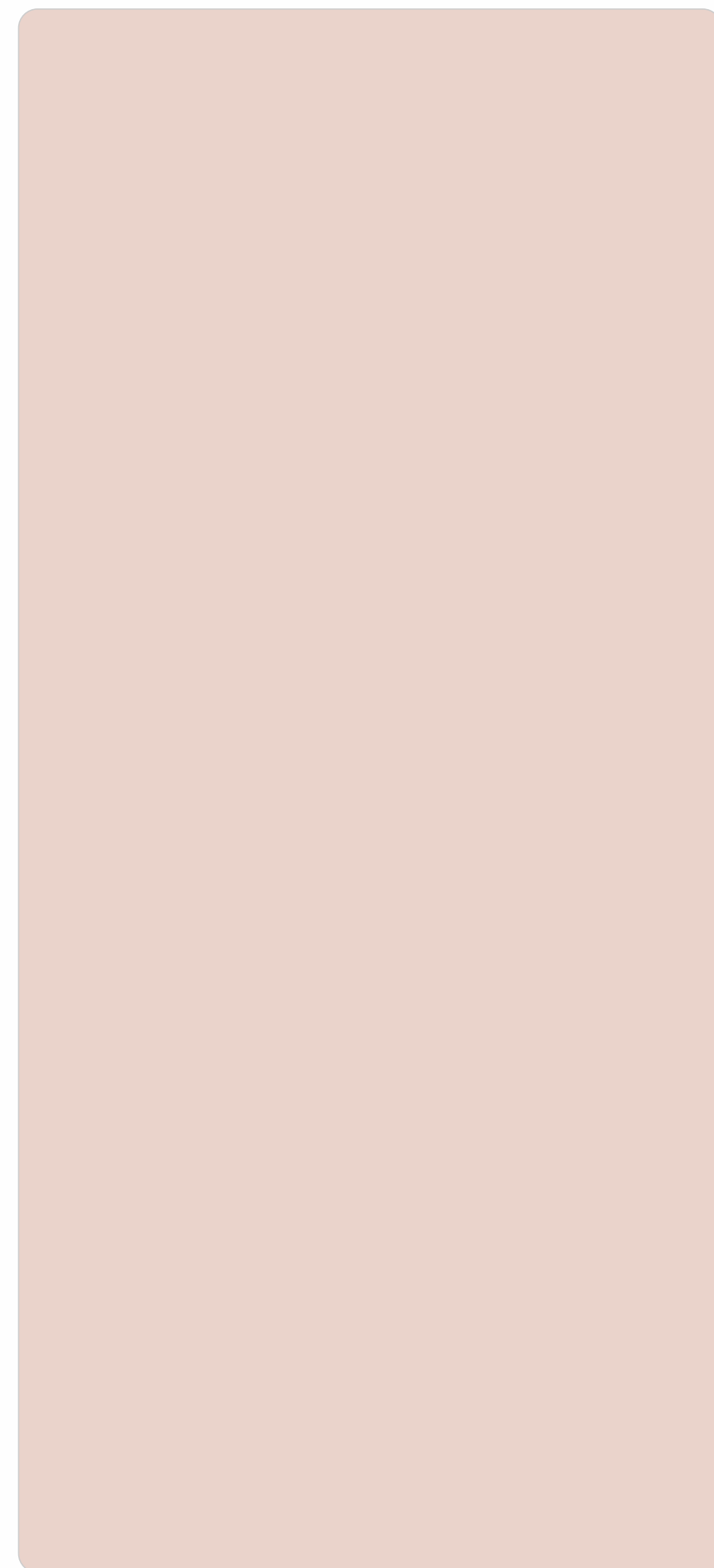

KO-MT-414



KO-MT-415

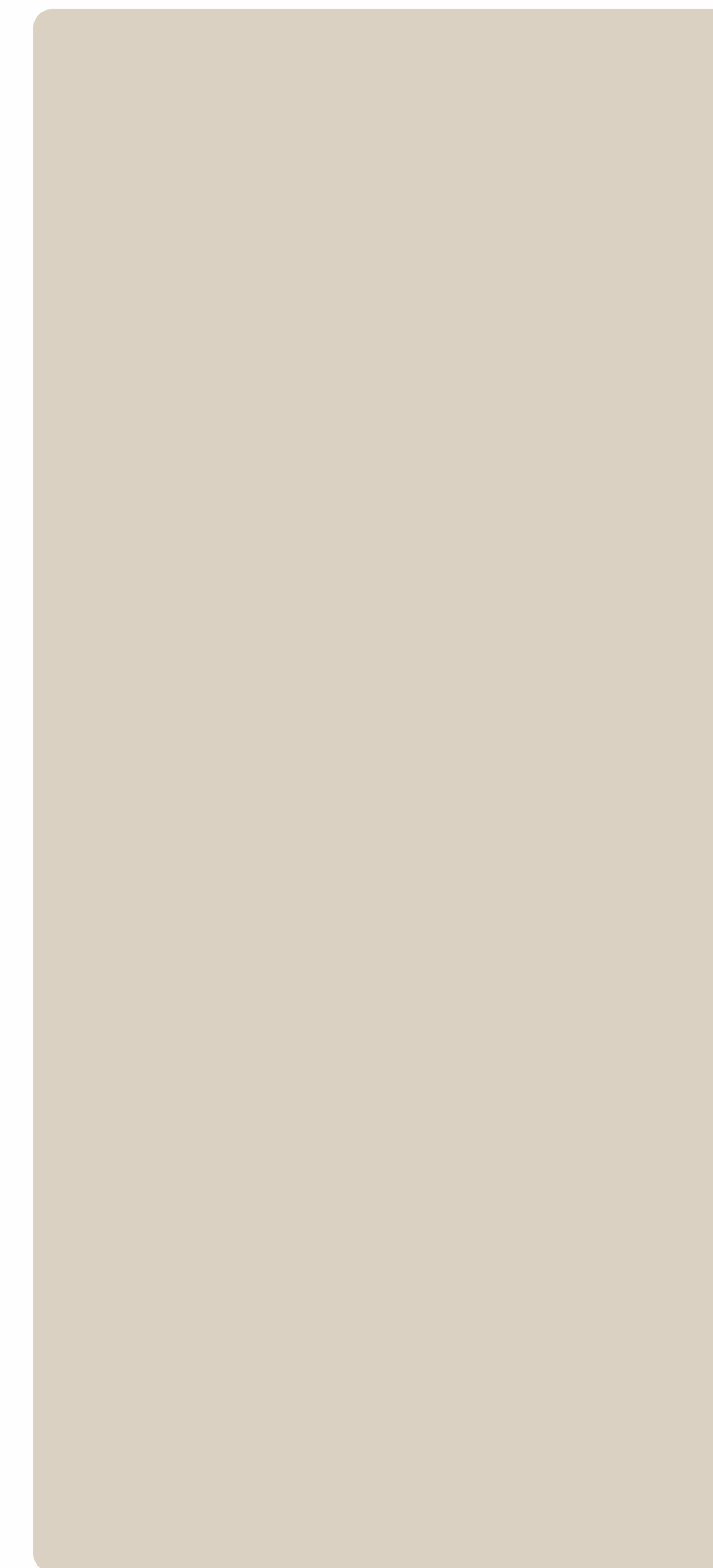

KO-MT-405

 **MATT
FINISH**

 **WELMICA**
LAMINATES

KOREAN Sheet
CORE ACRYLIC LAMINATE

Crafted for Designers,
Loved by Spaces.

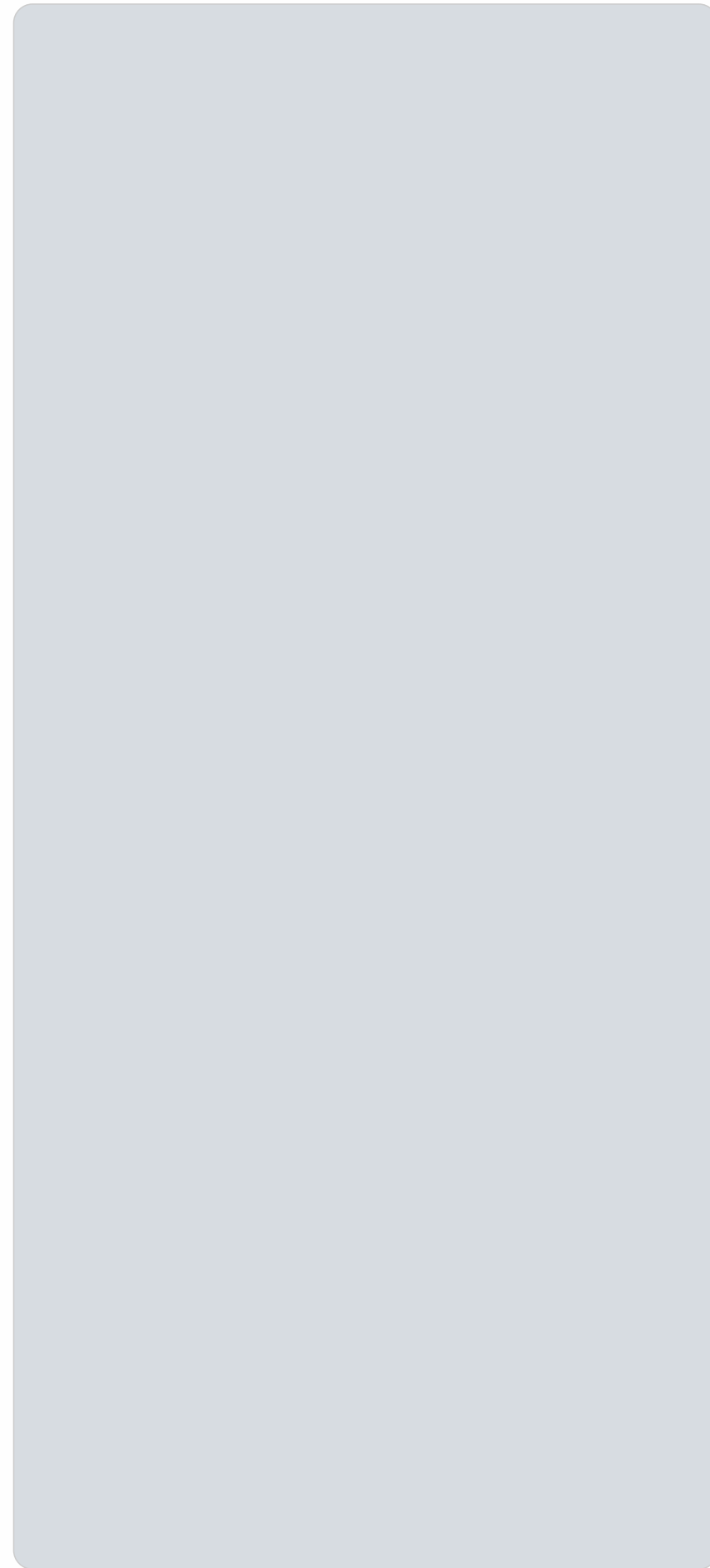

KO-MT-460

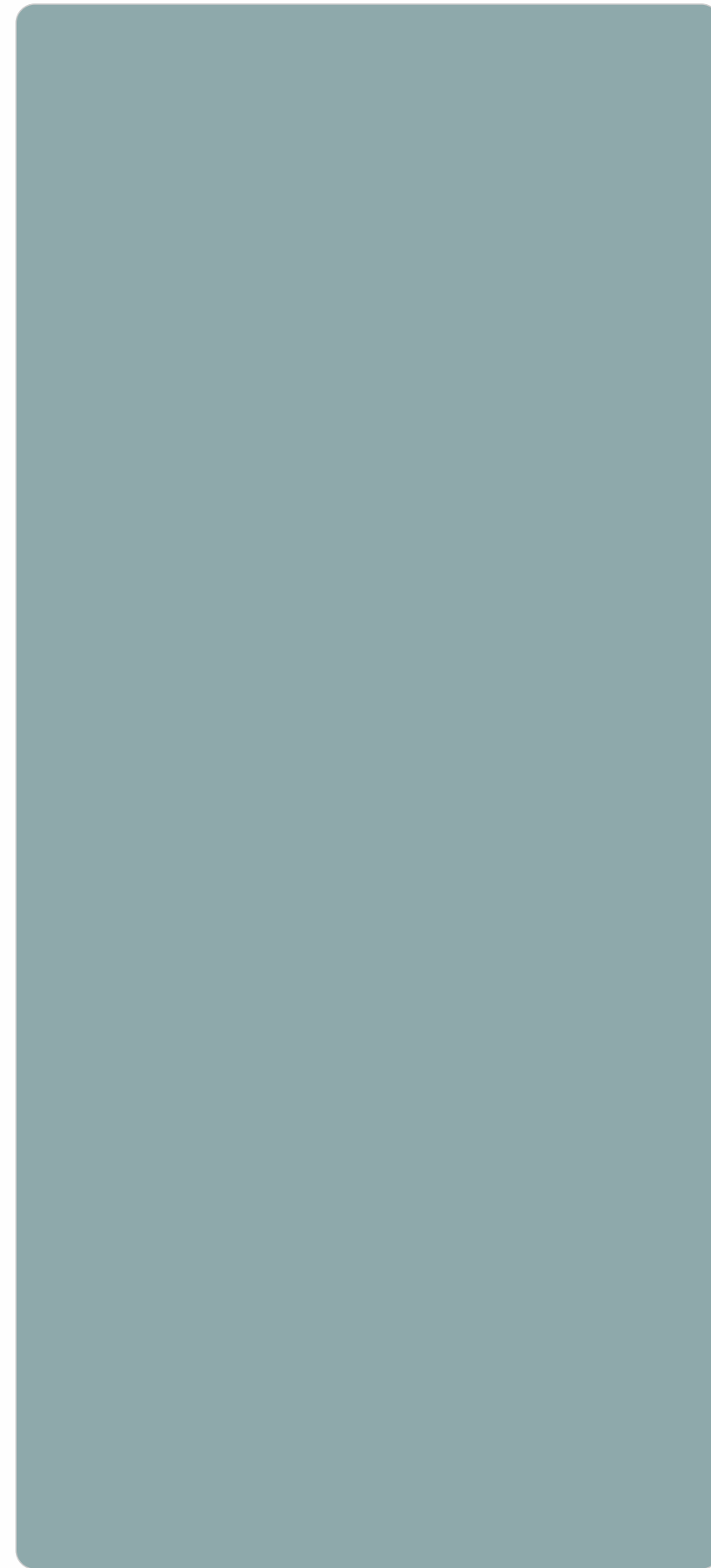

KO-MT-461

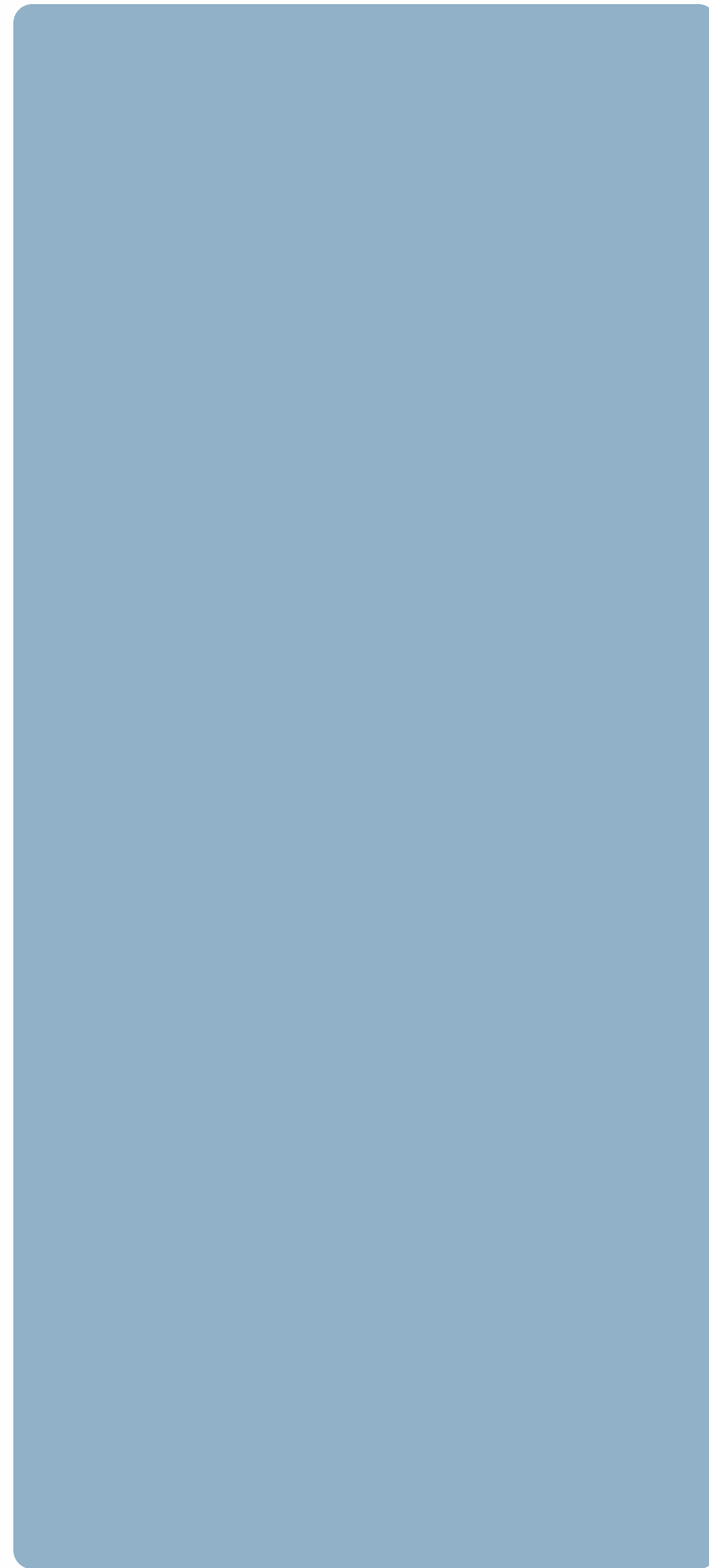

KO-MT-462



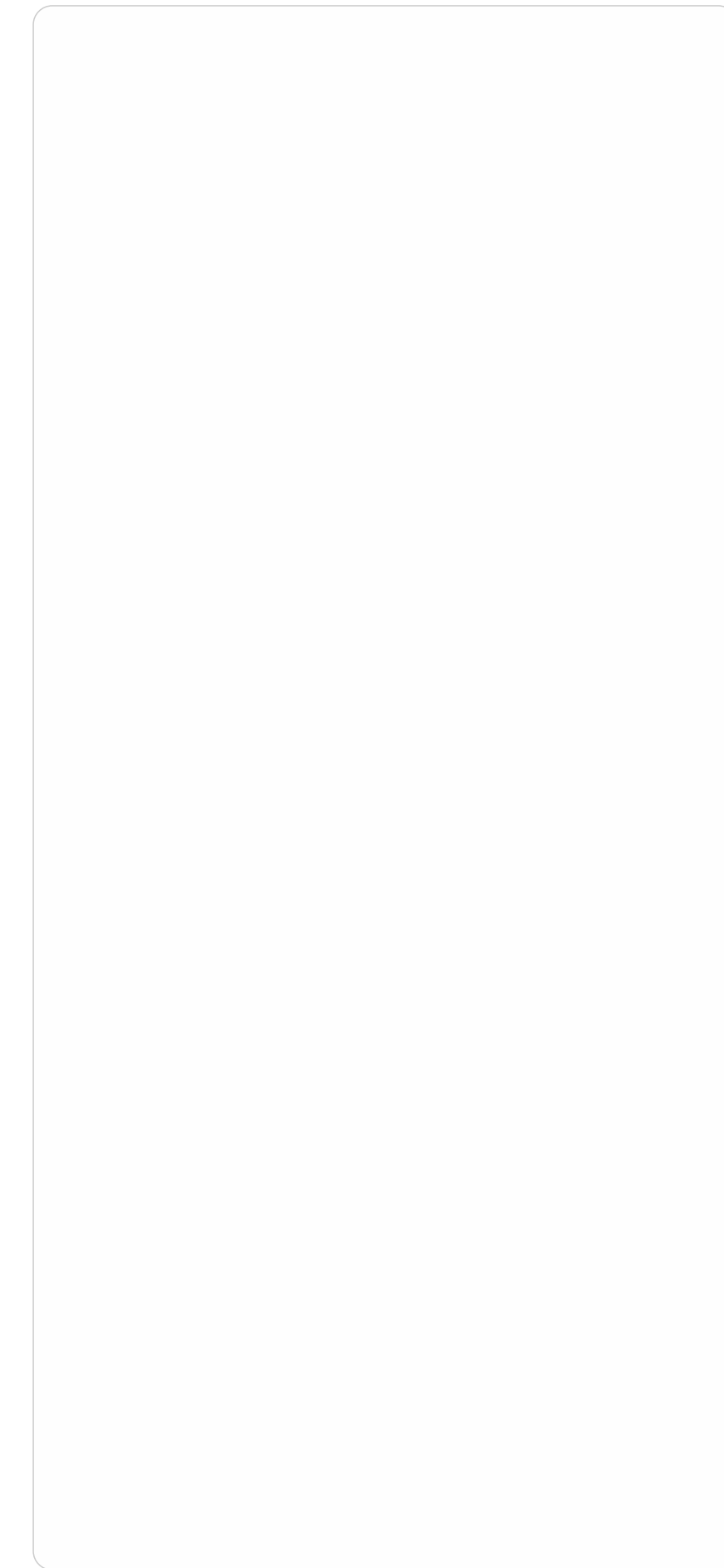

KO-MT-401



crafted to deliver
unmatched durability and
aesthetic appeal.

Transforming Interiors
with Crystal Precision.

Shine
brighter
brighter
brighter

Technical Specification

	WELMICA KOREAN SHEET	PVC	ACRYLIC	UV
Before	Korean - STD	PVC-STD	POLY - STD	UV - STD
After (300 hr)	Koren- 300 hr E=2.5	PVC - 300 hr	POLY - 300 hr E=3.0	UV - 300 hr E=10.0

	WELMICA KOREAN SHEET	ACRYLIC
Pencil Hardness	HB	HB
Rockwell Hardness	93	87

	ACRYLIC	UV	PVC	WELMICA KOREAN SHEET
Eco-Friendly	✗	✗	✗	✓
Weather Resistance	✗	✗	✓	✓
Smoothness	✗	✗	✓	✓
2nd Processability	✗	✗	✓	✓
A/S Availability	✗	✗	✓	✓
Heat Resistance	✗	✗	✗	✓



Recommended Adhesive For ACRYLIC SHEETS

Special Wood Adhesive for PVC, Acrylic & Charcoal Sheet

IMPORTANT NOTE
ON COLOR CONSISTENCY :

Please note that slight color variations may occur in materials produced from different manufacturing batches. To ensure uniformity and maintain a consistent appearance, it is strongly recommended to use acrylic sheets from the same batch for any single project. Additionally, the colors displayed in this brochure are for reference purposes only.